

Digital Indicator

SD24 Series

Instruction Manual

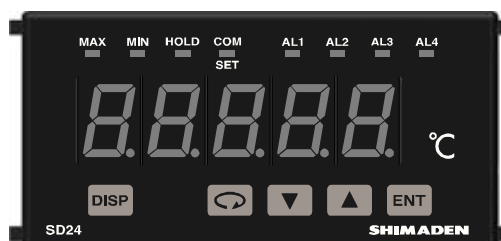

Please be sure to provide the end user with these instructions.

Preface



Thank you for purchasing a Shimaden product.

After making sure the product you have is the one you specified, get a good understanding of the instructions to ensure proper operation and handling.

This document contains precautions, mounting method, wiring/function descriptions and operation method for those involved in wiring, installing and performing routine maintenance for the SD24 Series.

Keep the instructions in a handy place when operating/handling the SD24 Series and be sure to adhere to the instructions contained herein.



Safety precautions and precautions concerning equipment damage and other additional explanations are provided under the following labeling.

 WARNING	Matters that could result in injury or death if instructions are not followed.
 Caution	Matters that could result in equipment damage if instructions are not followed.

Note Additional explanations or matters requiring special attention.

Safety precautions

 WARNING
The SD24 Series digital indicators are designed to indicate temperature, humidity and other physical amounts for general industrial equipment. You should either take appropriate safety measures or avoid using for control that could have a serious effect on human life. The digital indicator should be housed in the control box, etc., to keep the terminal elements from being accidentally touched. Do not remove the indicator from its case, or insert your fingers or electric conductors inside the case. Doing so could result in electric shock accident involving death or serious injury.

 Caution
If there is danger of damage to any peripheral device or equipment due to failure of the indicator, you should take appropriate safety measures such as mounting a fuse or overheating prevention device.
An alert  symbol is printed on the terminal nameplate applied to the case. Alert marks are provided to call your attention to the fact that you could be shocked if you touch charged parts.
Provide a switch or breaker as a means of cutting off power for external power circuit connected to the power terminal of the indicator. Mount a switch or breaker near the indicator where the operator can get to it easily and label it as an electrical breaker for the indicator.

Fuses
The indicator does not have a built-in fuse. Be sure to mount a fuse on the power circuit connected to the power terminal.
Provide a fuse between the switch or breaker and the indicator. Mount on the L side of the power terminal.
Fuse rating/characteristics: 250V AC, 1.0A/medium or slow blowing
Voltage/current of load connected to the output terminal (analog output) and alert terminal should be within the rating.
Using voltage/current that exceeds the rating could shorten the life of the product by raising the temperature, and could result in equipment failure.
For rating, see "8. Specifications."
Connect equipment that conforms to requirements for IEC61010-1 to the output terminal.
Do not apply voltage/current other than rated input to the input terminal. Doing so could shorten the life of the product or result in equipment failure.
For rating, see "8. Specifications."
If the input is voltage (mV or V) or current (mA), connect equipment that conforms to IEC61010-1 to the input terminal.
Be careful not to allow foreign matter such as metal to get into the draft holes for heat dissipation. Doing so could result in equipment failure or fire.
Do not allow the draft holes to become clogged with dust, etc. Doing so could shorten the life of the product due to temperature rise or insulation deterioration, and could result in equipment failure. For space between instruments to be mounted, see "2.3 External dimensions and panel cutout."
Note that repeating endurance tests such as dielectric strength, noise resistance and surge resistance could negatively affect the indicator.
The user should absolutely not modify or use the indicator other than the way it was intended.

Contents

1. Introduction.....	3
1.1 Preliminary check	3
1.2 Precautions when using	3
2. Installation and wiring	4
2.1 Installation site (environmental conditions).....	4
2.2 Installation	4
2.3 External dimensions and panel cutout	4
2.4 Wiring	4
2.5 Terminal layout	5
3. Front panel	5
3.1 Parts	5
3.2 Description.....	6
4. Error messages.....	6
5. Screen.....	7
5.1 Screen sequence.....	7
5.2 Power on screen group.....	10
5.3 Mode 0 screen group.....	10
5.4 Mode 1 screen group.....	11
5.5 Mode 2 screen group.....	14
6. Function.....	16
6.1 Maximum value (MAX) / minimum value (MIN).....	16
6.2 Hold function	16
6.3 DI function.....	16
7. Optional functions	17
7.1 Alarm output	17
7.2 Analog output.....	18
7.3 Setting the square-root extraction function.....	19
7.4 10-segment linear approximation	19
7.5 Sensor DC power supply	20
8. Specifications.....	21

1. Introduction

1.1 Preliminary check

The equipment undergoes a thorough quality inspection before shipment from the factory. You should however make sure there is nothing wrong with the specification code, appearance or accessories.

Specification code check

Compare the specification code on the case with the following to make sure it is the product you ordered.

Item	Code	Specifications
1. Series	SD24 -	48 x 96 DIN size digital indicator, DI 2 points
2. Input	8	Multi input • Thermocouple • R.T.D. (Pt100, JPt100) • Voltage (mV) Input resistance: 500kΩ min. For details concerning input types and measuring range, see "8. Specifications measuring range codes." Inverse scaling possible for voltage (mV) (Note 1)
	6	Voltage (V) DC Input resistance: 500KΩ min. Inverse scaling possible (Note 1)
	4	Current (mA) DC Internal receiving impedance: 250Ω
3. Power	90-	100 – 240V AC±10% (50/60Hz)
	08-	24V AC (50/60Hz) / DC ±10%
4. Alarm output (optional)	0	Without
	1	Output 4 points (AL1/AL2/AL3/AL4, contact a) (AL1/AL2 and AL3/AL4 are COM shared) Contact capacity 240V AC, 2A / resistive load
	2	Output 2 points (AL1/AL2, contact c) Contact capacity 240V AC, 2.5A / resistive load
5. Analog output/communication (optional) (Note 2)	00	Without
	03	0 – 10mV DC, output resistance 10Ω
	04	4 – 20 mA DC, load resistance 300Ω max.
	06	0 – 10V DC, load current 2 mA max.
	50	RS-485
	70	RS-232C
6. DC power supply for sensor (optional)	0	Without
	1	24V DC, 50 mA
7. Remarks	0	Without
	9	With (Please consult before ordering.)

* **Note 1** Scaling range: -9999 – 30000 unit
Span: 10 – 40000 unit

* **Note 2** Select either analog output or communication

Accessories check

Unit seal: 1

Communication instruction manual: 1 (if optionally equipped with communication)

Note

In the event you want to inquire about a product defect, missing accessory or other matter, please contact your nearest Shimaden agent.

1.2 Precautions when using

Do not operate the front panel keys with hard or pointed objects. Always press the keys lightly with the tips of your fingers. To clean, wipe lightly with a dry cloth. Do not use solvents such as thinner.

2. Installation and wiring

2.1 Installation site (environmental conditions)



Caution

Do not use in the following locations. Doing so could lead to equipment failure, damage or fire.

- Places exposed to flammable or corrosive gases, oil mist, or excessive dust that could cause insulation to deteriorate
- Places where ambient temperature may fall below -10°C or rise above 50°C
- Places where ambient humidity may exceed 90% RH or places subject to condensation
- Places subject to strong vibration or impact
- Places near strong electric circuit or places subject to inductive interference
- Places exposed to water dripping or direct sunlight
- Places where altitude exceeds 2000 m

Note Among environmental conditions, IEC60664 installation category II, pollution class 2.

2.2 Installation

- 1) Cut a hole for mounting the indicator by referring to the cutout drawing in section 2.3. The panel thickness should be 1.0 – 4.0 mm.
- 2) The indicator is provided with tabs for mounting. Insert as is from the front surface of the panel.

Note SD24 indicators are panel mounted indicators. Be sure to mount on the panel.

2.3 External dimensions and panel cutout

External dimensions

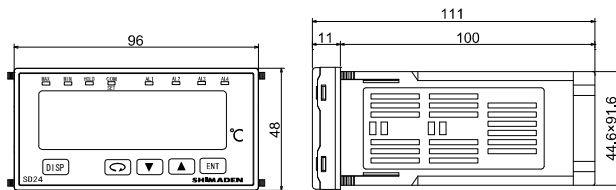

Unit: mm

Panel cutout

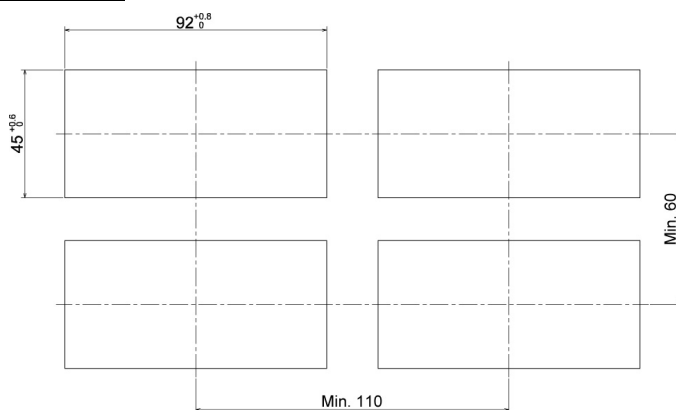

Unit: mm

2.4 Wiring



WARNING

Do not supply power when wiring. Doing so could result in electrical shock. Be sure to ground the protective conductor terminal (⊕). Failure to ground could result in electrical shock. After wiring, do not touch terminal elements or other charged parts while conducting electricity.

Be sure to wire in accordance with "2.5 Terminal layout."

Use a crimp-type terminal that matches an M3.5 screw and is no wider than 7 mm.

For thermocouple input, use a compensating conductor that matches the type of thermocouple.

Arrange so that external resistance does not exceed 100Ω.

For R.T.D. input, resistance for lead wires should be a maximum of 5Ω per wire. All 3 wires should have the same resistance.

Input signal wires must not be accommodated with a strong electric circuit in the same conduit or duct.

Using shielded wiring (single point grounding) is effective for static induction noise.

Making input wiring short and twisting at regular intervals is effective for electromagnetic induction noise.

For power supply, use wiring or cable with sectional area of at least 1 mm² that offers the same performance as 600V vinyl insulated wiring.

The ground wire should be at least 2 mm² and the ground resistance should not exceed 100Ω.

The symbol ⊥ indicates the location of the function ground terminal. Ground if possible to avoid the effect of noise, etc.

Securely fasten the terminal element screw.

Fastening torque: 1.1N · m (11kgf · cm)

Noise filter

If the instrument appears to be easily affected by power supply noise, use a noise filter to prevent malfunctioning.

Mount the noise filter on the grounded panel and make the wire connection between the noise filter output and power line terminals of the indicator as short as possible.

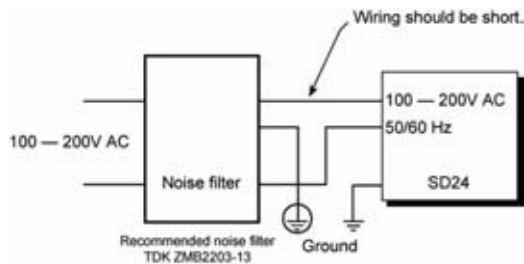

2.5 Terminal layout

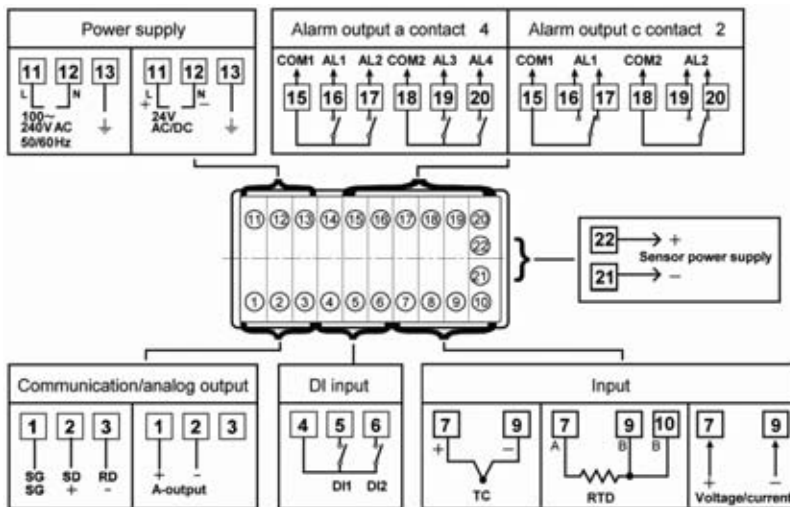

Note Do not connect an input other than the stipulated input to the terminals.

3. Front panel

3.1 Parts

Front panel

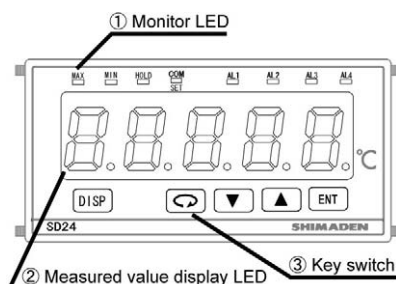

3.2 Description

① Monitor LED

MAX: Maximum PV value display monitor LED (green)

Lights when maximum PV value is displayed.

MIN: Minimum PV value display monitor LED (green)

Lights when minimum PV value is displayed.

HOLD: Hold PV value display monitor LED (green)

Lights when hold PV value is displayed.

COM/SET: Communication / parameter setting monitor LED (green)

Lights when in the communication mode.

Flickers on/off for mode 1 and mode 2 screen groups.

AL1: Alarm 1 output monitor LED (red)

Lights when alarm 1 is output.

AL2: Alarm 2 output monitor LED (red)

Lights when alarm 2 is output.

AL3: Alarm 3 output monitor LED (red)

Lights when alarm 3 is output.

AL4: Alarm 4 output monitor LED (red)





Lights when alarm 4 is output.

② Measured value display LED (red)

Displays current parameter PV value on basic screen (screen 0-0).

Displays and sets parameters for each mode screen group.

③ Key switch operation section

	Display key Switches PV display from current value → maximum value → minimum value → current value.
	Parameter key Pressing this key displays the next display screen. Toggles between mode 0 screen group and mode 1 screen group. Press and hold for approximately 2 seconds to switch from 0-0 to 1-0 screen group and vice versa.
	Down key Decrements parameter values on the setting screens. The decimal point of the lowest digit flickers on/off until the value is entered by the ENT key.
	Up key Increments parameter values on the setting screens. The decimal point of the lowest digit flickers on/off until the value is entered by the ENT key.
	ENT (enter) key Enters parameters modified by the up and down keys on the setting screens. Toggles between display and setting screens. When doing so, the decimal point of the lowest digit stops flickering on/off.

4. Error messages

The following error messages are displayed on the basic screen (0-0):

HHHH	When any of the following occurs ① Break in thermocouple input wiring ② Break in R.T.D. input A wiring ③ If PV value exceeds higher limit of measurement range by approximately 10% ④ If scaling value exceeds 32,000 for voltage or current input
LLLL	If PV value falls below lower limit of measurement range by approximately 10%
CUHH	If cold junction (CJ) is abnormal on higher limit side during thermocouple input
CULL	If cold junction (CJ) is abnormal on lower limit side during thermocouple input
b---	If B of R.T.D. (terminal No. ⑨ or ⑩) is broken or if A, B or more than one B is broken

5. Screen

5.1 Screen sequence

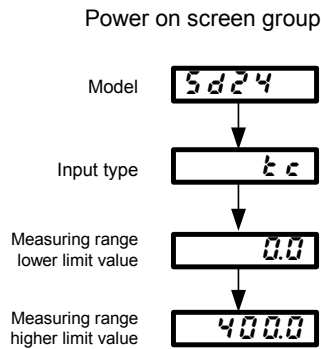

The following conditions are indicated by the screen frame display:

- Screen always displayed
- Screen displayed under certain conditions
- Screen displayed when equipped with optional items

Key operation for power on screen group

The screens of the power on screen group change automatically and therefore do not require key operation. Displays input type and measuring range set for the device.

Key operation for mode 0 screen group

The mode 0 screen group consists of items that are used frequently during operation. The main key operations are as follows.

• Advance display screen.	
• Switch from display screen to setting screen.	
• Switch back to display screen from setting screen.	
• Switch from 0-0 screen to 1-0 screen.	
• Press and hold approx. 2 seconds.	

Key operation for mode 1 and 2 screen group

Consists of setting screens, etc., that are not used as frequently as the 0 screen group and are modified as needed according to input condition, control, etc. The main key operations are as follows.

• Advance display screen.	
• Move back display screen.	
• Switch from display screen to setting screen.	
• Switch back to display screen from setting screen.	
• Switch back to initial screen of mode screen from either mode 1 or 2 screen.	
• Switch back to 0-0 screen.	
• Switch back from 1-0 screen to 0-0 screen.	

Auto return function

Automatically switches back to basic screen if not key operation is performed for 3 minutes when screen other than basic screen (screen 0-0) is displayed.

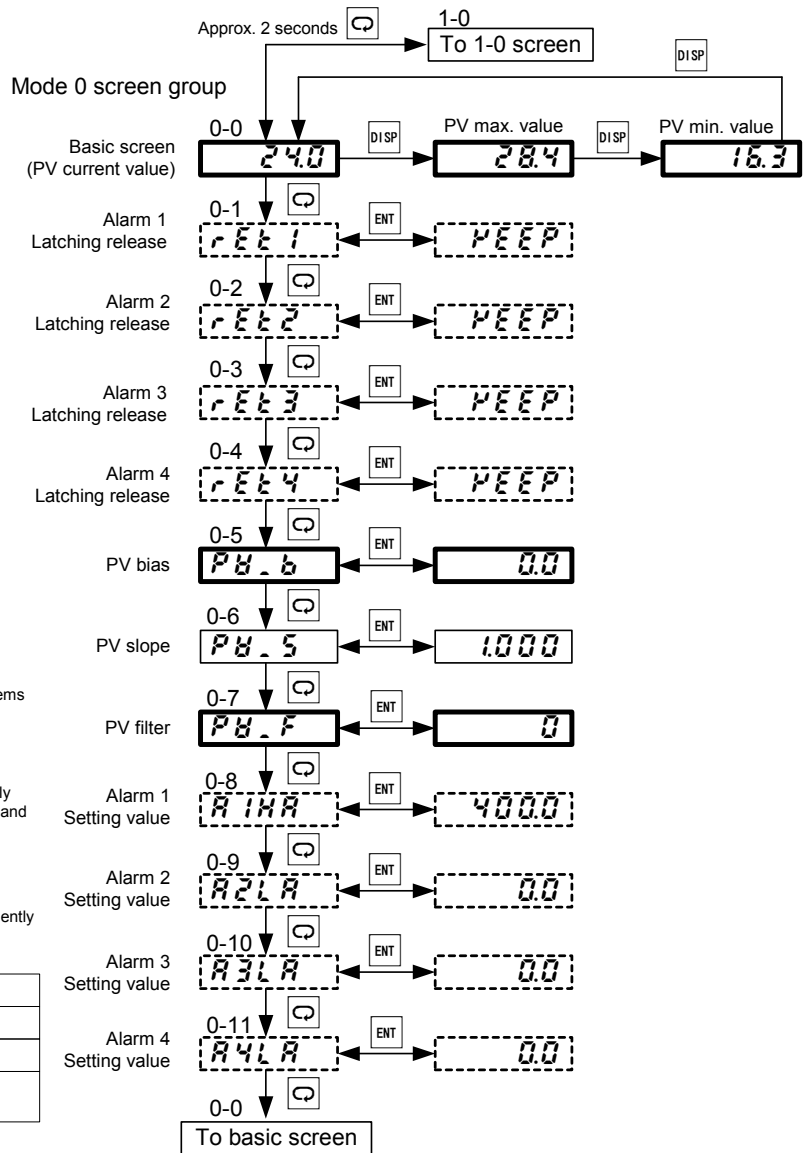

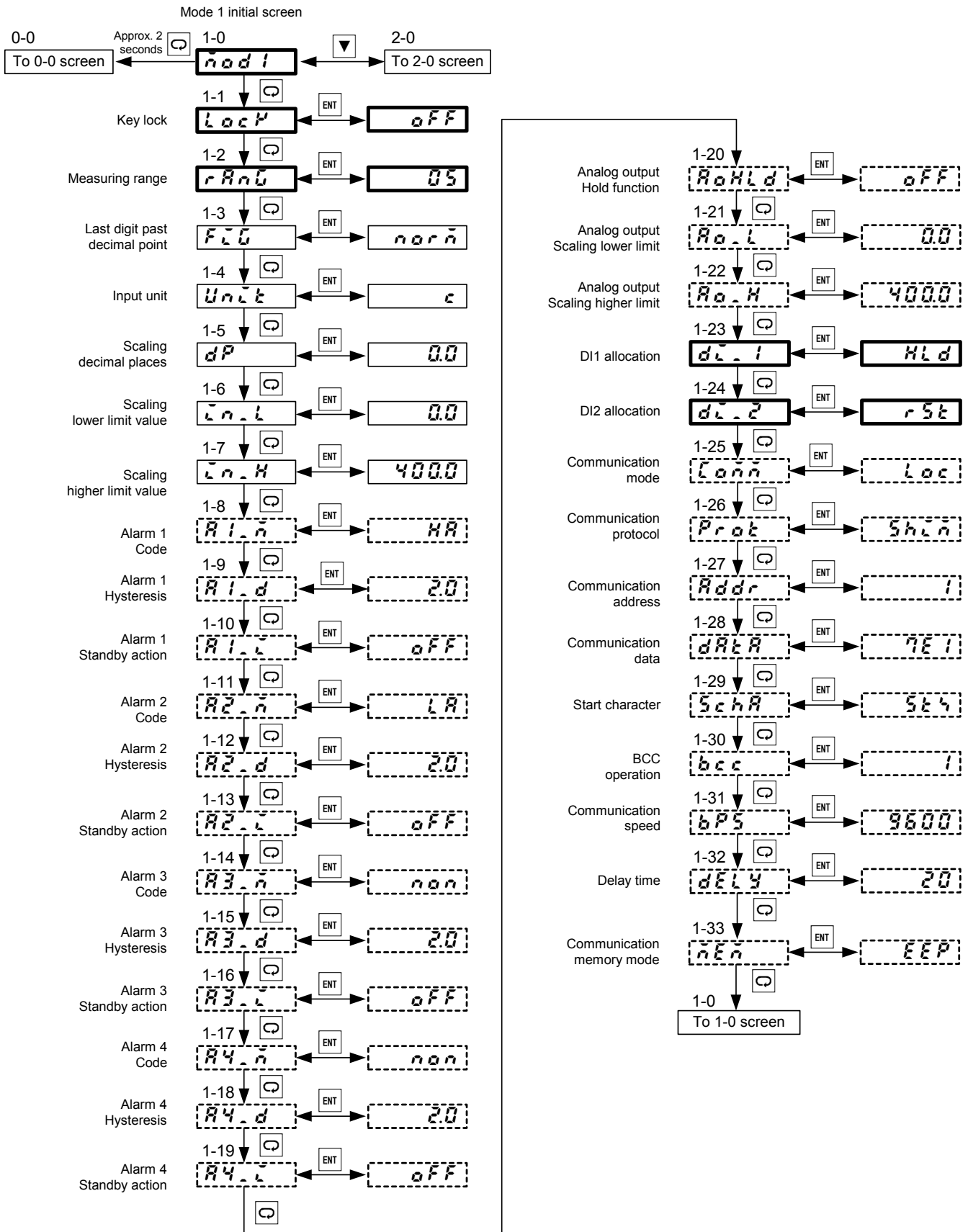

Mode 2 initial screen

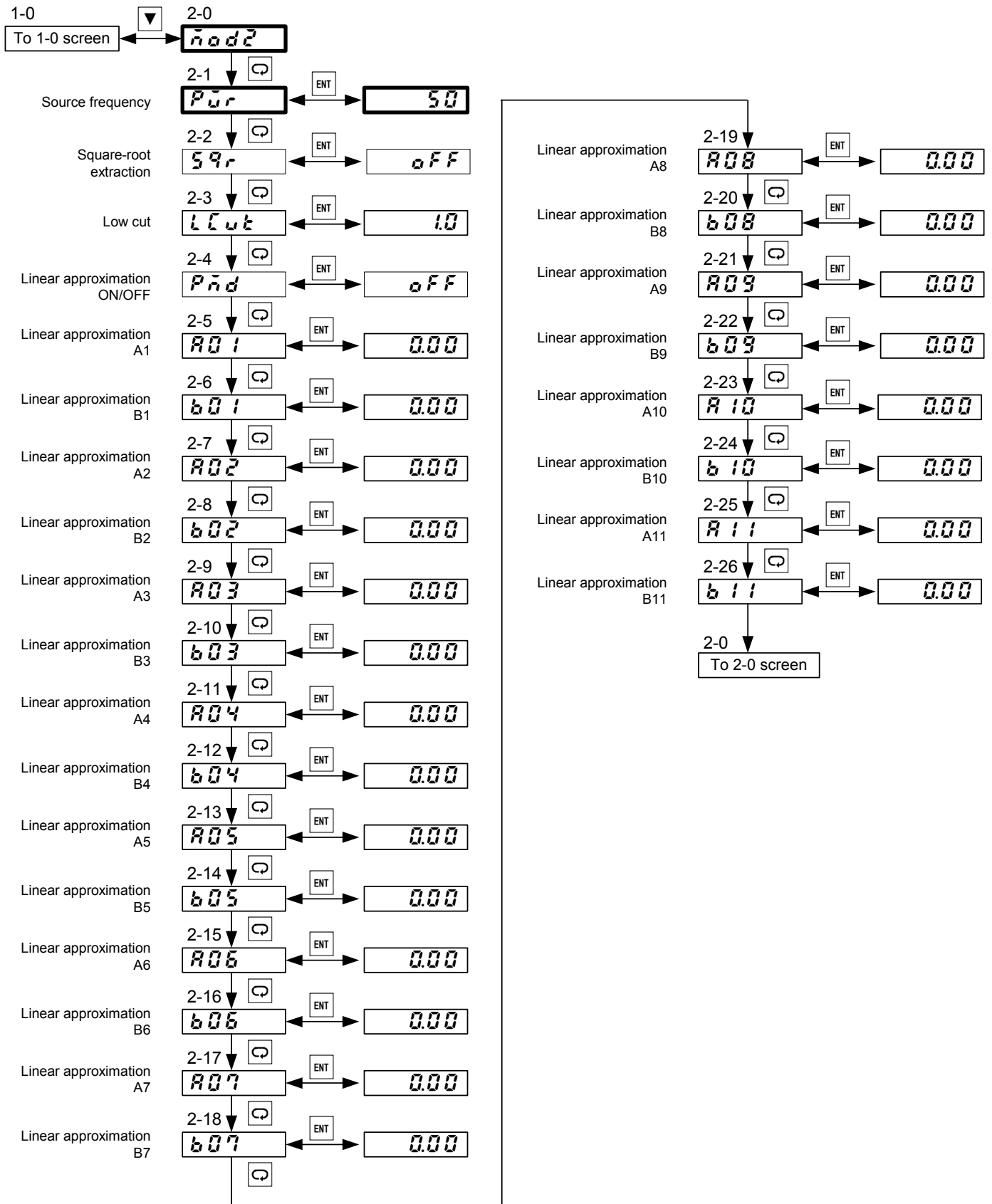

5.2 Power on screen group

The following information is automatically displayed when the power is turned on.
The example shows the information when shipped from the factory.

Product name

5d24

Indicates product name (SD24).

Input

tc

Indicates type of input.
TC (thermocouple), Pt (R.T.D.), mV, V or mA

Measuring range lower limit value

0.0

Indicates input measuring range lower limit value.

Measuring range higher limit value

4000

Indicates input measuring range higher limit value.

5.3 Mode 0 screen group

The following information icons are used here to facilitate explanation.

	Setting/display enable when optionally equipped with alarm		Setting/display enable when optionally equipped with analog output
	Setting/display enable when optionally equipped with communication		
	Setting/display enable when using voltage/current input for measuring range		Setting/display enable when using voltage/current input for measuring range
	Setting range		Initial value

0-0 Basic screen

24.0

Displays PV value.

Note

Press to display maximum (MAX) or minimum (MIN) value.

0-1 Alarm 1 unlatching

rEE1

Indicates alarm 1 status. Can be unlatched.

Sets alarm 1 code to type with latching function (screen 1-8) and indicates when latched. To reset alarm output, set to RSET.

For more information on the latching function, see [7.1 Latching function for alarm output](#).
KEEP: Latch
RSET: Unlatch

KEEP, RSET

KEEP

0-2 Alarm 2 unlatching

rEE2

Indicates alarm 2 status. Can be unlatched.

Sets alarm 2 code to type with latching function (screen 1-11) and indicates when latched. To reset alarm output, set to RSET.

For more information on the latching function, see [7.1 Latching function for alarm output](#).
KEEP: Latch
RSET: Unlatch

KEEP, RSET

KEEP

0-3 Alarm 3 unlatching

rEE3

Indicates alarm 3 status. Can be unlatched.

Sets alarm 3 code to type with latching function (screen 1-14) and indicates when latched. To reset alarm output, set to RSET.

For more information on the latching function, see [7.1 Latching function for alarm output](#).
KEEP: Latch
RSET: Unlatch

KEEP, RSET

KEEP

0-4 Alarm 4 unlatching

rEE4

Indicates alarm 4 status. Can be unlatched.

Sets alarm 4 code to type with latching function (screen 1-17) and indicates when latched. To reset alarm output, set to RSET.

For more information on the latching function, see [7.1 Latching function for alarm output](#).
KEEP: Latch
RSET: Unlatch

KEEP, RSET

KEEP

0-5 PV bias setting

PB_b

Sets/displays PV bias value.

This value is used to offset input error of sensors, etc. When set, displays offset value.

-9999 – 10000 unit

0 Unit

0-6 PV slope setting

PB_S

Sets/displays PV slope value.

This value is used to offset input error of sensors, etc. When set, displays offset value.

0.500 – 1.500

1.000

0-7 PV filter setting

PB_F

Sets/displays PV filter time.

This value helps control the effect of PV input noise.

Note

PV filter is temporarily ineffective when resetting from scale over.

0 – 100 seconds

0

0-8 Alarm 1 setting value

A1HA

Alarm type set by alarm 1 code (screen 1-8) is displayed. Set the alarm setting values.

The second and third from last dots light when the latching function is employed.

A1HA : Higher limit absolute value
A1LA : Lower limit absolute value
A1H.A : Higher limit absolute value (with latching function)
A1L.A : Lower limit absolute value (with latching function)

Note

Screen is not displayed when alarm 1 code (screen 1-8) is "non" (none) or in the case of So (scale over).

See [8. Specifications Setting Range](#) Refer to initial values.

0-9 Alarm 2 setting value

A2LA

Alarm type set by alarm 2 code (screen 1-11) is displayed. Set the alarm setting values.

AL

The second and third from last dots light when the latching function is employed.

- A2HA : Higher limit absolute value
- A2LA : Lower limit absolute value
- A2H.A : Higher limit absolute value (with latching function)
- A2L.A : Lower limit absolute value (with latching function)
- A2dHi : Deviation higher limit value
- A2dLo : Deviation lower limit value
- A2dHL : Deviation higher/lower limit value
- A2d.H.i : Deviation higher limit value (with latching function)
- A2d.L.o : Deviation lower limit value (with latching function)
- A2d.H.L : Deviation higher/lower limit value (with latching function)

Note

Screen is not displayed when alarm 2 code (screen 1-11) is "non" (none) or in the case of So (scale over).

Range

See 8. Specifications Setting Range

Init.

Refer to initial values.

0-10 Alarm 3 setting value

A3LA

This screen is not displayed when contact c alarm is selected.

AL

Alarm type set by alarm 3 code (screen 1-14) is displayed. Set the alarm setting values.

The second and third from last dots light when the latching function is employed.

- A3A : Higher limit absolute value
- A3LA : Lower limit absolute value
- A3H.A : Higher limit absolute value (with latching function)
- A3L.A : Lower limit absolute value (with latching function)

Note

Screen is not displayed when alarm 3 code (screen 1-14) is "non" (none) or in the case of So (scale over).

Range

See 8. Specifications Setting Range

Init.

Refer to initial values.

0-11 Alarm 4 setting value

A4LA

This screen is not displayed when contact c alarm is selected.

AL

Alarm type set by alarm 4 code (screen 1-17) is displayed. Set the alarm setting values.

The second and third from last dots light when the latching function is employed.

- A4HA : Higher limit absolute value
- A4LA : Lower limit absolute value
- A4H.A : Higher limit absolute value (with latching function)
- A4L.A : Lower limit absolute value (with latching function)
- A4dHi : Deviation higher limit value
- A4dLo : Deviation lower limit value
- A4dHL : Deviation higher/lower limit value
- A4d.H.i : Deviation higher limit value (with latching function)
- A4d.L.o : Deviation lower limit value (with latching function)
- A4d.H.L : Deviation higher/lower limit value (with latching function)

Note

Screen is not displayed when alarm 4 code (screen 1-17) is "non" (none) or in the case of So (scale over).

Range

See 8. Specifications Setting Range

Init.

Refer to initial values.

5.4 Mode 1 screen group

1-0 Mode 1 initial screen

Mod1

First screen of the mode 1 screen group.

1-1 Key lock

LOCK

Sets/displays key lock status. The concerned parameter data cannot be modified when key lock is set to ON.

- OFF : All keys can be operated.
- LOCK1: Only key lock and mode 0 screen group parameters can be modified.
- LOCK2: Only key lock can be modified.

Range

OFF, LOCK1, LOCK2

Init.

OFF

1-2 Measuring range

rAng

Sets/displays type of input. For details on selections, see 8. Specifications Measuring Range Codes.

Note

When measuring range is modified, the contents of all parameters are initialized. Be careful when doing so. Measuring range display type varies according to the required product specifications. If the necessary range code does not appear, see the specification code.

Range

See 8. Specifications Setting Range

Init.

05 (Universal-input)
86 (Voltage input)
95 (Current input)

1-3 Decimal point last digit switch

FLG

Sets/indicates whether or not last digit past the decimal point decided by the range code is to be displayed.

mV
V
mA

norm: Displays measuring range indicated in measuring range code table.

Shrt : Rounds off the last digit of the measuring range indicated in the measuring range code table; digits below the decimal point are not displayed.

Note

If set to "Shrt," the last digit of input scaling, analog output scaling, alarm setting value, hysteresis, and PV bias are rounded off. If changed from "Shrt," to "norm," the last digit of input scaling, analog output scaling, alarm setting value, hysteresis, and PV bias are set to zero.

Range

norm, Shrt

Init.

norm

1-4 Input unit

Unit

Sets/displays input unit.

mV
V
mA

Range

°C, °F

Init.

°C

1-5 Input scaling decimal point position

dP

Sets/displays scaling decimal point position for voltage/current input.

mV
V
mA

Note

In case other than voltage/current input (Thermocouple and R.T.D. input) only displays scaling decimal position.

Range

nnnn. – n.nnn

Init.

n.nn

1-6 Input scaling lower limit value

LnL

Sets/displays scaling lower limit value for voltage/current input.

mV
V
mA

Note

In case other than voltage/current input (Thermocouple and R.T.D. input) only displays scaling lower limit value. Span between lower and higher limit values is 10 – 40,000. Inverse scaling is possible.

Range

-9999 – 30000 unit

Init.

0 unit

1-7 Input scaling higher limit value

1-7.H Sets/displays scaling higher limit value for voltage/current input. mV
V
mA

Note In case other than voltage/current input (Thermocouple and R.T.D. input) only displays scaling higher limit value. Span between lower and higher limit values is 10 – 40,000. Inverse scaling is possible.

Range -9999 – 30000 unit **Init** 10000 unit

1-8 Alarm 1 code

1-8.n Sets/displays type of alarm 1 action. AL
For details on various types of action, see 7.1 Types of action for alarm output.
non : None
HA : Higher limit absolute value
LA : Lower limit absolute value
HA_L : Higher limit absolute value (with latching function)
LA_L : Lower limit absolute value (with latching function)
So : Scaleover

Note If alarm code is modified, hysteresis, standby action and alarm setting value are reset. The values are however not reset if HA is changed to HA_L or vice versa, or LA is changed to LA_L or vice versa.

Range non, HA, LA, HA_L, LA_L, So **Init** HA

1-9 Alarm 1 hysteresis

1-9.d Sets/displays alarm hysteresis. AL

Note Screen is not displayed when alarm 1 code (screen 1-8) is non or in the case of So.

Range 1 – 9999 unit **Init** 20 unit

1-10 Alarm 1 standby action

1-10.c Sets/displays type of alarm 1 standby action. AL

Note Screen is not displayed when alarm 1 code (screen 1-8) is non or in the case of So.

Range OFF, ON **Init** OFF

1-11 Alarm 2 code

1-11.n Sets/displays type of alarm 2 action. AL
For details on various types of action, see 7.1 Types of action for alarm output.
non : None
HA : Higher limit absolute value
LA : Lower limit absolute value
HA_L : Higher limit absolute value (with latching function)
LA_L : Lower limit absolute value (with latching function)
So : Scaleover

The following are not displayed when alarm code is non or So.

dHi : Deviation higher limit value
dLo : Deviation lower limit value
dHL : Deviation higher/lower limit value
dHi_L : Deviation higher limit value (with latching function)
dLo_L : Deviation lower limit value (with latching function)
dHL_L : Deviation higher/lower limit value (with latching function)

Note Setting contents are initialized if alarm code is modified. The values are however not initialized if HA is changed to HA_L, LA is changed to LA_L, dHi is changed to dHi_L, dLo is changed to dLo_L, dHL is changed to dHL_L or vice versa. The deviation setting is the value relative to alarm 1.

Range non, HA, LA, HA_L, LA_L, So, dHi, dLo, dHL, dHi_L, dLo_L, dHL_L **Init** LA

1-12 Alarm 2 hysteresis

1-12.d Sets/displays alarm 2 hysteresis. AL

Note Screen is not displayed when alarm 2 code (screen 1-11) is non or in the case of So.

Range 1 – 9999 unit **Init** 20 unit

1-13 Alarm 2 standby action

1-13.c Sets/displays type of alarm 2 standby action. AL

Note Screen is not displayed when alarm 2 code (screen 1-11) is non or in the case of So.

Range OFF, ON **Init** OFF

1-14 Alarm 3 code

1-14.n This screen is not displayed when contact c alarm is selected. AL

Sets/displays type of alarm 3 action.

For details on various types of action, see 7.1 Types of action for alarm output.

non : None
HA : Higher limit absolute value
LA : Lower limit absolute value
HA_L : Higher limit absolute value (with latching function)
LA_L : Lower limit absolute value (with latching function)
So : Scaleover

Note Setting contents are reset if alarm code is modified. The values are however not reset if HA is changed to HA_L or vice versa, or LA is changed to LA_L or vice versa.

Range non, HA, LA, HA_L, LA_L, So **Init** non

1-15 Alarm 3 hysteresis

1-15.d This screen is not displayed when contact c alarm is selected. AL

Sets/displays alarm 3 hysteresis.

Note Screen is not displayed when alarm 3 code (screen 1-14) is non or in the case of So.

Range 1 – 9999 unit **Init** 20 unit

1-16 Alarm 3 standby action

1-16.c This screen is not displayed when contact c alarm is selected. AL

Sets/displays type of alarm 3 standby action.

Note Screen is not displayed when alarm 3 code (screen 1-14) is non or in the case of So.

Range OFF, ON **Init** OFF

1-17 Alarm 4 code

AL

This screen is not displayed when contact c alarm is selected.

Sets/displays type of alarm 4 action.
For details on various types of action, see 7.1 Types of action for alarm output.

non : None
HA : Higher limit absolute value
LA : Lower limit absolute value
HA_L : Higher limit absolute value (with latching function)
LA_L : Lower limit absolute value (with latching function)
So : Scaleover

The following are not displayed when alarm code 3 is non or So.
dHi : Deviation higher limit value
dLo : Deviation lower limit value
dHL : Deviation higher/lower limit value
dHi_L : Deviation higher limit value (with latching function)
dLo_L : Deviation lower limit value (with latching function)
dHL_L : Deviation higher/lower limit value (with latching function)

Note Setting contents are initialized if alarm code is modified. The values are however not initialized if HA is changed to HA_L, LA is changed to LA_L, dHi is changed to dHi_L, dLo is changed to dLo_L, dHL is changed to dHL_L or vice versa. The deviation setting is the value relative to alarm 3.

Range non, HA, LA, HA_L, LA_L, So **Init** non
dHi, dLo, dHL, dHi_L, dLo_L, dHL_L

1-18 Alarm 4 hysteresis

AL

This screen is not displayed when contact c alarm is selected.

Sets/displays alarm 4 hysteresis.

Note Screen is not displayed when alarm 4 code (screen 1-17) is non or in the case of So.

Range 1 – 9999 unit **Init** 20 unit

1-19 Alarm 4 standby action

AL

This screen is not displayed when contact c alarm is selected.

Sets/displays type of alarm 4 standby action.

Note Screen is not displayed when alarm 4 code (screen 1-17) is non or in the case of So.

Range OFF, ON **Init** OFF

1-20 Analog output hold function

Ao

Analog output selection when hold is employed. Selects whether to output the value when hold is employed or to output the current value regardless of the value when hold is employed.

OFF : Outputs current PV value.
ON : Outputs hold value.

Range OFF, ON **Init** OFF

1-21. Analog output scaling lower limit value

Ao

Sets/displays scaling lower limit value of analog output.

Note Inverse scaling is possible. The same value cannot be set for both higher limit value and lower limit value (screen 1-22).

Range Measuring range lower limit value - higher limit value **Init** Lower limit value

1-22 Analog output scaling higher limit value

Ao

Sets/displays scaling higher limit value of analog output.

Note Inverse scaling is possible. The same value cannot be set for both higher limit value and lower limit value (screen 1-21).

Range Measuring range lower limit value - higher limit value **Init** Higher limit value

1-23 DI1 code

AL

Sets/displays type of DI1 action.

non : None
HLd : Hold function (when holding current input)
rSt : Resets maximum value (MAX) and minimum value (MIN).
L_rS : All unlatch

Note The same type of action as the DI2 setting (other than non) cannot be selected.

Range non, HLd, rSt, L_rS **Init** HLd

1-24 DI2 code

AL

Sets/displays type of DI2 action.

non : None
HLd : Hold function (when holding current input)
rSt : Resets maximum value (MAX) and minimum value (MIN).
L_rS : All unlatch

Note The same type of operation as the DI1 setting (other than non) cannot be selected.

Range non, HLd, rSt, L_rS **Init** rSt

1-25 Communication mode

Com

Sets/displays communication mode.

LOC : Local mode
Enables reading of data through communication.
COM : Communications mode
Enables setting and reading of data through communication.
COM of Monitor LED lights.

Note If you set communication mode to COM through communication, setting can no longer be carried out by front panel keys. You can however change from COM to LOC. For details, see the Communication Interface Instruction Manual.

Range LOC, COM **Init** LOC

1-26 Communication protocol

Com

Sets/displays communication protocol.

SHIM: Shimaden standard protocol
ASC : MODBUS ASCII
RTU : MODBUS RTU

Range SHIM, ASC, RTU **Init** SHIM

1-27 Communication address

Com

Sets/displays communication address.

Range 1 – 255 **Init** 1

1-28 Communication data format

Com

Sets/displays data format for communications.

The setting value consists of a 3-digit number.
Left digit : Data length (bits) 7 or 8
Middle digit : Parity E (even) or N (none)
Right digit : Stop bit 1 or 2

Note Only 7-bit format can be set for MODBUS ASCII. The initial setting is 7E1. Only 8-bit format can be set for MODBUS RTU. The initial setting is 8E1.

Range 7E1, 7E2, 7N1, 7N2, 8E1, 8E2, **Init** 7E1 or 8E1
8N1, 8N2

1-29 Communication start character

5c hA		Sets/displays communication start character.	Com
STX	Start character	STX (02H)	
	Text end	ETX (03H)	
	End character	CR (0DH)	
ATT	Start character	@ (40H)	
	Text end	: (3AH)	
	End character	CR (0DH)	

Note Start character is not used for MODBUS ASCII or RTU.

Range STX, ATT **Init.** STX

1-30 BCC operating method

bcc		Sets/displays BCC operating method.	Com
1:	Add operation from start character to text end		
2:	Add operation from start character to text end and complement of 2 of the result		
3:	Exclusive disjunction (XOR) operation of add operation immediately after start character to text end		
4:	No BCC operation		

Note BCC is not used for MODBUS ASCII or RTU.

Range 1 – 4 **Init.** 1

1-31 Communication speed

bPS		Sets/displays communication speed.	Com
------------	--	------------------------------------	------------

Note

Range 2400, 4800, 9600, 19200 bps **Init.** 9600

1-32 Delay time

dELY		Sets/displays delay time from when communication command is received till transmission.	Com
-------------	--	---	------------

Range 1 – 100 msec **Init.** 20

1-33 Memory mode setting

rEm		Selects destination of writing of communication data.	Com
EEP :	Writes data in EEPROM.		
rAm :	Writes data in RAM.		
r_E :	Writes alarm data in RAM and other data in EEPROM.		

Note When the power is turned back on, COM of monitor LED lights for rAm / r_E and settings by using front panel keys are disabled. You can however change from COM to LOC.

Range EEP, rAm, r_E **Init.** EEP

5.5 Mode 2 screen group

2-0 Mode 2 initial screen

mode First screen of the mode 2 screen group.

2-1. Power frequency

Pur Sets/displays power frequency.

Note Does not have to be set under ordinary circumstances. If the PV value (measured value) display wobbles, set to the same value as the source frequency.

Range 50, 60 **Init.** 50

2-2 Square-root extraction

59r Sets/displays square-root extraction. **mV V mA**

Note Ineffective during inverse scaling. Cannot be set during thermocouple or R.T.D. input.

Range OFF, ON **Init.** OFF

2-3 Low cut

LCut Sets/displays low cut. **mV V mA**

Note Not displayed when square root extraction(screen 2-2) is OFF.

Range 0.0 – 5.0 **Init.** 1.0

2-4 Linear approximation

Pnd Sets/displays linear approximation function. **mV V mA**

Note Ineffective during inverse scaling. Cannot be set during thermocouple or R.T.D. input.

Range OFF, ON **Init.** OFF

2-5 Linear approximation A1

RD1 Sets/displays linear approximation A1. **mV V mA**

Note Not displayed when linear approximation (screen 2-4) is OFF.

Range -5.00 – 105.00 **Init.** 0.00

2-6 Linear approximation B1

bD1 Sets/displays linear approximation B1. **mV V mA**

Note Not displayed when linear approximation (screen 2-4) is OFF.

Range -5.00 – 105.00 **Init.** 0.00

2-7 Linear approximation A2

RD2 Sets/displays linear approximation A2. **mV V mA**

Note Not displayed when linear approximation (screen 2-4) is OFF.

Range -5.00 – 105.00 **Init.** 0.00

2-8 Linear approximation B2

bD2 Sets/displays linear approximation B2. **mV V mA**

Note Not displayed when linear approximation (screen 2-4) is OFF.

Range -5.00 – 105.00 **Init.** 0.00

2-9 Linear approximation A3**A03**

Sets/displays linear approximation A3.

mV
V
mA**Note** Not displayed when linear approximation (screen 2-4) is OFF.**Range** -5.00 – 105.00**Init.** 0.00**2-10 Linear approximation B3****b03**

Sets/displays linear approximation B3.

mV
V
mA**Note** Not displayed when linear approximation (screen 2-4) is OFF.**Range** -5.00 – 105.00**Init.** 0.00**2-11 Linear approximation A4****A04**

Sets/displays linear approximation A4.

mV
V
mA**Note** Not displayed when linear approximation (screen 2-4) is OFF.**Range** -5.00 – 105.00**Init.** 0.00**2-12 Linear approximation B4****b04**

Sets/displays linear approximation B4.

mV
V
mA**Note** Not displayed when linear approximation (screen 2-4) is OFF.**Range** -5.00 – 105.00**Init.** 0.00**2-13 Linear approximation A5****A05**

Sets/displays linear approximation A5.

mV
V
mA**Note** Not displayed when linear approximation (screen 2-4) is OFF.**Range** -5.00 – 105.00**Init.** 0.00**2-14 Linear approximation B5****b05**

Sets/displays linear approximation B5.

mV
V
mA**Note** Not displayed when linear approximation (screen 2-4) is OFF.**Range** -5.00 – 105.00**Init.** 0.00**2-15 Linear approximation A6****A06**

Sets/displays linear approximation A6.

mV
V
mA**Note** Not displayed when linear approximation (screen 2-4) is OFF.**Range** -5.00 – 105.00**Init.** 0.00**2-16 Linear approximation B6****b06**

Sets/displays linear approximation B6.

mV
V
mA**Note** Not displayed when linear approximation (screen 2-4) is OFF.**Range** -5.00 – 105.00**Init.** 0.00**2-17 Linear approximation A7****A07**

Sets/displays linear approximation A7.

mV
V
mA**Note** Not displayed when linear approximation (screen 2-4) is OFF.**Range** -5.00 – 105.00**Init.** 0.00**2-18 Linear approximation B7****b07**

Sets/displays linear approximation B7.

mV
V
mA**Note** Not displayed when linear approximation (screen 2-4) is OFF.**Range** -5.00 – 105.00**Init.** 0.00**2-19 Linear approximation A8****A08**

Sets/displays linear approximation A8.

mV
V
mA**Note** Not displayed when linear approximation (screen 2-4) is OFF.**Range** -5.00 – 105.00**Init.** 0.00**2-20 Linear approximation B8****b08**

Sets/displays linear approximation B8.

mV
V
mA**Note** Not displayed when linear approximation (screen 2-4) is OFF.**Range** -5.00 – 105.00**Init.** 0.00**2-21 Linear approximation A9****A09**

Sets/displays linear approximation A9.

mV
V
mA**Note** Not displayed when linear approximation (screen 2-4) is OFF.**Range** -5.00 – 105.00**Init.** 0.00**2-22 Linear approximation B9****b09**

Sets/displays linear approximation B9.

mV
V
mA**Note** Not displayed when linear approximation (screen 2-4) is OFF.**Range** -5.00 – 105.00**Init.** 0.00**2-23 Linear approximation A10****A10**

Sets/displays linear approximation A10.

mV
V
mA**Note** Not displayed when linear approximation (screen 2-4) is OFF.**Range** -5.00 – 105.00**Init.** 0.00**2-24 Linear approximation B10****b10**

Sets/displays linear approximation B10.

mV
V
mA**Note** Not displayed when linear approximation (screen 2-4) is OFF.**Range** -5.00 – 105.00**Init.** 0.00**2-25 Linear approximation A11****A11**

Sets/displays linear approximation A11.

mV
V
mA**Note** Not displayed when linear approximation (screen 2-4) is OFF.**Range** -5.00 – 105.00**Init.** 0.00**2-26 Linear approximation B11****b11**

Sets/displays linear approximation B11.

mV
V
mA**Note** Not displayed when linear approximation (screen 2-4) is OFF.**Range** -5.00 – 105.00**Init.** 0.00

6. Function

6.1 Maximum value (MAX) / minimum value (MIN)

PV maximum value (MAX) / minimum value (MIN) is displayed by key operation.

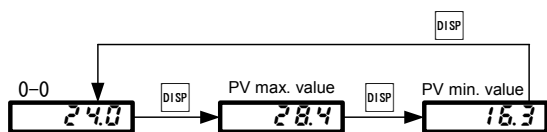

When PV maximum value (MAX) is displayed, the MAX monitor LED lights.

When PV minimum value (MIN) is displayed, the MIN monitor LED lights.

Note

- To reset the PV maximum value (MAX) / minimum value (MIN), simultaneously press the ▲ and ▼ keys on the basic screen (screen 0-0). You can also reset by rSt (max/min value reset) of DI.
- PV maximum value (MAX) / minimum value (MIN) is cleared when the power is turned off.
- PV maximum value (MAX) / minimum value (MIN) is as follows when a CJHH, CJLL or b--- error message occurs:

Status	PV maximum value display	PV minimum value display
CJHH	HHHH	Retained minimum value
CJLL	Retained maximum value	LLLL
b---	Retained maximum value	LLLL

6.2 Hold function

The hold function holds (retains) the measured value when DI is ON. When hold is activated, the HOLD monitor LED lights and the hold value is displayed with priority given to the current measured value and subsequent.

Maximum (MAX) and minimum (MIN) value can be displayed by key operation during hold.

Hold values when in hold status are cleared when the power is turned off. The value when the power is turned back on is then held.

Note

- The hold value display is maintained even if the device displays an error message during hold.
- Alarm output is in accordance with the PV current value.
- For analog output during hold, select the hold value or current value for analog output hold function (screen 1-20).
- PV value for communication during hold is the hold value.
- If the measuring range (screen 1-2) or the last digit past the decimal point position is changed (screen 1-3) during hold, the hold value is cleared and the value when the device is restarted is held.

6.3 DI function

The device can be controlled by external control input.

No. of inputs: 2 points (DI1 / DI2)

Type	Description of operation	Signal detection
non	No processing	----
HLd	Hold function (when holding current input value)	Level
rSt	Resets maximum value (MAX) and minimum value (MIN).	Edge
L_rS	All unlatch	Edge

Note

- ON/OFF must be maintained for at least 0.1 seconds to detect DI input.
Level: Continues operation when DI input is on.
Edge: Operated by startup signal of DI input on and continues to operate even after DI input is off.
- With the exception of "non," the same operation cannot be allotted to both DI1 and DI2.
- Data is not saved in the memory for DI on/off; if power is turned off and then back on, rSt and L_rS operation is off.
HLd operates by DI input.

7. Optional functions

7.1 Alarm output

Two types of alarm function can be optionally added.

- (1) a contact output (alarm 1 – 4)
- (2) c contact output (alarm 1 – 2)

Types of operation

Types of alarm output operation (screen 1-8, 1-11, 1-14 or 1-17) and setting range are as follows: Alarm value is set by screen 0-8, 0-9, 0-10 or 0-11.

Code	Name	Setting range	Initial value
HA	Higher limit absolute value alarm	Within range	Range higher limit value
LA	Lower limit absolute value alarm	Within range	Range lower limit value
HA_L	Higher limit absolute value alarm (with latching function)	Within range	Range higher limit value
LA_L	Lower limit absolute value alarm (with latching function)	Within range	Range higher limit value
So	Scaleover	----	----
dHi	Deviation higher limit value alarm	-9999 – 19999	19999 unit
dLo	Deviation lower limit value alarm	-9999 – 19999	-9999 unit
dHL	Deviation higher/lower limit value alarm	1 – 19999	19999 unit
dHi_L	Deviation higher limit value alarm (with latching function)	-9999 – 19999	19999 unit
dLo_L	Deviation lower limit value alarm (with latching function)	-9999 – 19999	-9999 unit
dHL_L	Deviation higher/lower limit value alarm (with latching function)	1 – 19999	19999 unit

Alarm operation diagram

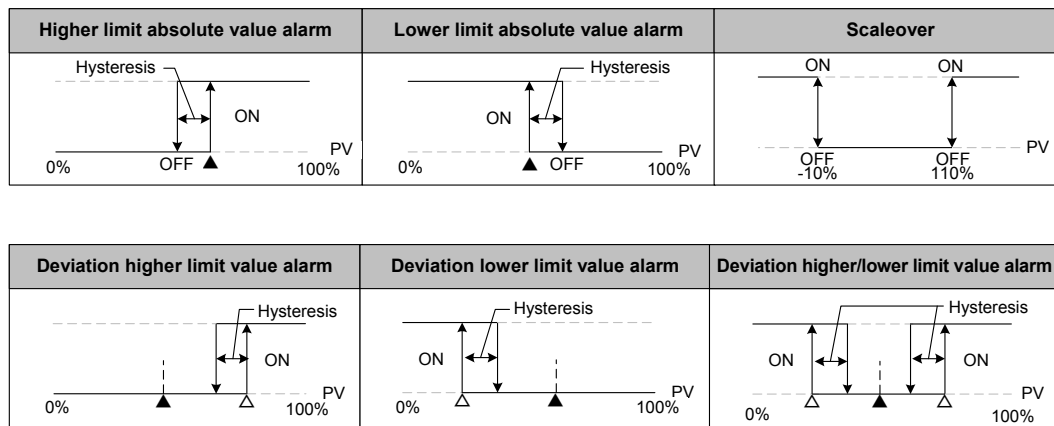

▲(Alarm setting) △(Deviation alarm setting)

Deviation alarm is a function whereby an alarm is output for a preset deviation value that specifies the target deviation. The function is as given in the following table.

Alarm output for target deviation		Deviation alarm output
Alarm 1	→	Alarm 2
Alarm 3	→	Alarm 4

Latching function

The latching function is a function whereby the alarm continues to be output even if the value changes to a value outside the alarm range after a value within the alarm range was detected and the alarm was first output.

Note

Unlatching cannot be conducted if the PV value is in the alarm range. For information concerning unlatching, see screen 0-1, 0-2, 0-3, 0-4 and 6.3 DI Function.

Equipped with latching function

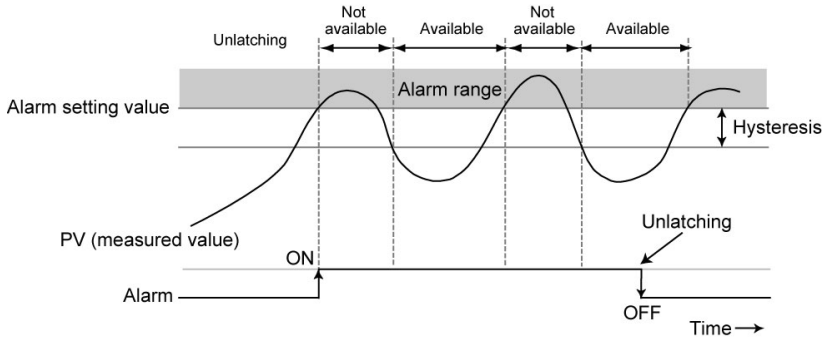

Standby action

Setting alarm output standby action to ON (screen 1-10 or 1-13, 1-16, 1-19) enables you to keep the alarm from being output when power is applied as follows.

In the following figure, alarm type is set to HA. With standby action, the alarm is not output while the power is on even if alarm output conditions are satisfied. The alarm is output when the value re-enters the alarm range after once moving out of the range.

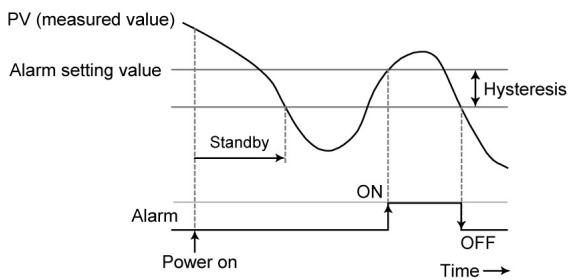

7.2 Analog output

Analog output is a function whereby analog voltage or current is output according to the measured value. Setting the analog output scaling lower limit value (screen 1-21) and higher limit value (screen 1-22) enables analog output signal according to measured value within a certain measuring range.

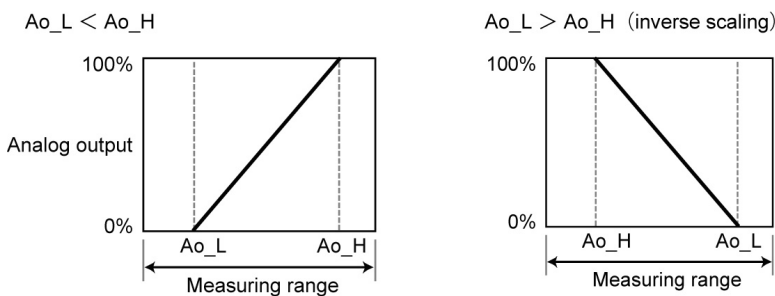

Select whether to output analog output in hold as the hold value or as the current PV value. (Screen 1-20)

The initial value is the current PV value.

Note: Relations between error messages and output (for positive scaling)

Error messages	Analog output
HHHH	100%
LLLL	0%
CJHH	100%
CJLL	0%
b---	0%

7.3 Setting the square-root extraction function

Set only for voltage or current input. Cannot be set for inverse scaling.
 Enables you to make a signal with square characteristics, such as current measurement, linear.
 Cannot be set for thermocouple or R.T.D. input.

Enabling square-root extraction function

Setting square-root extraction Sqr (screen 2-2) to ON enables the square-root extraction function.

Low cut

Functions when square-root extraction function is enabled only.
 With square-root extraction, results fluctuate significantly due to slight fluctuation of input values near signal zero. Low cut is a function that outputs zero for PV when below a preset input value. Prevents operation from becoming unstable when noise gets in the input signal.
 Low cut setting range is 0.0 – 5.0% of PV input range.

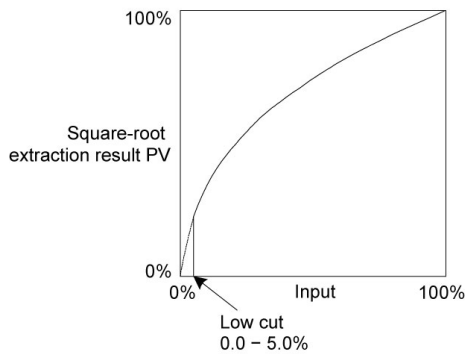

7.4 10-segment linear approximation

Enabling 10-segment linear approximation

Set only for voltage or current input. Ineffective during inverse scaling.
 Function that makes a nonlinear PV input signal linear by linear approximation.
 Cannot be set for thermocouple or R.T.D. input.

Curve point setting

Sets curve point for linear approximation input clearance.
 You can set up to 11 points. Set 11 points (A1 – A11) for PV input (%) and 11 points (B1 – B11) for PV display (%).
 Curve points B1 for A1, B2 for A2, up to B11 for A11; linear interpolation is executed among the various curve points.

Setting example

The following figure gives an example where 4 curve points are set for A1, B1 – A6 , up to B6. The inclinations of (A1, B1) – (A2, B2) and (A5, B5) – (A6, B6) were previously applied to A6 and subsequent. Set so $A_n < A(n + 1)$.
 If $A_n \geq A(n + 1)$, $A(n + 1)$ and subsequent is invalid.

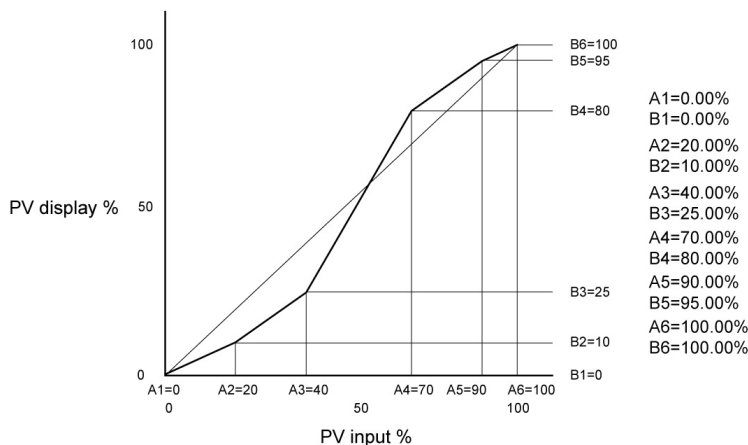

Note

- Will not operate with A1/B1 setting alone.
 When using linear approximation, set at least 2 points.

7.5 Sensor DC power supply

With this device, you can select the sensor DC power supply (24V DC, 50 mA), and can use it in combination with humidity sensor H71 and TH71 Series.

For voltage (V) input connection

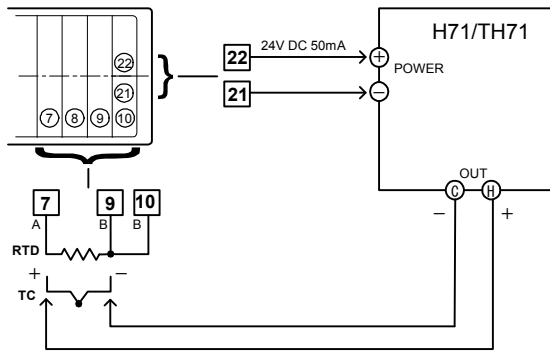

For current (mA) input connection

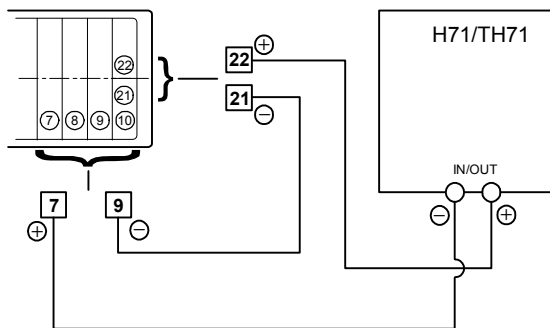

8. Specifications

Display	
Digital display	Measured value (PV) / 7-segment red LED, 5 digits
Action display	MAX (green): Lights when displaying PV maximum value. MIN (green): Lights when displaying PV minimum value. HOLD (green): Lights when displaying PV hold value. COM/SET (green): Lights when communication mode is set; flickers on/off when displaying parameters. AL1, AL2, AL3, AL4 (red): Lights during alarm output.
Display accuracy	$\pm(0.1\%FS+1\text{digit})$ within measuring range Does not however include cold junction temperature compensation tolerance of thermocouple input Accuracy guarantee not applicable when thermocouple B 400°C or below. Accuracy of thermocouple K, T readings below -100°C: Accuracy $\pm(0.5\%FS + 1 \text{ digit})$ Thermocouple PR40-20: Accuracy $\pm(0.3\%FS+^{\circ}C)$ Thermocouple metal / chromel: Accuracy $\pm(0.25\%FS+1k)$ For details, see 8. Specifications Measuring Range Codes .
Range for maintaining display accuracy	23°C \pm 5°C (18 – 28°C)
Display resolution	Differs according to measuring range (0.001, 0.01, 0.1, 1)
Measured value display range	-10 to 110% of measuring range (accuracy guarantee not applicable outside measuring range) 0.000 – 30.000°C of R.T.D. input, 0.00 – 300.00°C is 0.00 – 320.00°C For details, see 8. Specifications Measuring Range Codes .
Display update cycle	0.1 seconds

Setting	
Setting method	Equipped with setting protection function by key lock for front panel key switched (5).
Setting range	Same as for measuring range

Input	
Input type	Universal input (thermocouple, R.T.D., voltage [mV])
	Voltage (V)
	Current (mA)
Thermocouple	B, R, S, K, E, J, T, N (U, L[DIN43710]), WR5-26 For details, see 8. Specifications Measuring Range Codes .
Lead wire tolerable resistance	100Ω max.
Input resistance	500kΩ min.
Burnout function	Standard feature (up scale)
Cold junction compensation accuracy	$\pm 1^{\circ}C$ (within accuracy maintaining range [18 – 28°C])
R.T.D.	JIS Pt100 3-wire type, JPt100 3-wire type
Amperage	Approx. 1.1mA
Lead wire tolerable resistance	10Ω max. per wire (resistance for all wires must be equal)
Voltage	Input resistance 500kΩ min.
Current	0 – 20, 4 – 20mA DC receiving impedance 250Ω
Input scaling function	Possible during voltage (mV, V) or current (mA) input Inverse scaling can be set.
Scaling range	-9999 – 30000 count
Span	10 – 40000 count
Position of decimal point	None, 0.0, 0.00, 0.000
Sampling cycle	0.1 seconds
PV bias	-9999 – 10000 unit
PV slope	0.500 – 1.500 multiple
PV filter	0 – 100 sec. (filter off by 0 sec. setting)
Isolation	Isolated except for input and DI

Alarm output (optional)	
Number of alarm points	4 points (AL1/AL2/AL3/AL4) or 2 points (AL1/AL2)
Alarm types	The following 12 types can be assigned for each alarm. None Higher limit absolute value alarm (without latching function) Higher limit absolute value alarm (with latching function) Lower limit absolute value alarm (without latching function) Lower limit absolute value alarm (with latching function) Scaleover Deviation higher limit value alarm (without latching function) Deviation lower limit value alarm (without latching function) Deviation higher/lower limit value alarm (without latching function) Deviation higher limit value alarm (with latching function) Deviation lower limit value alarm (with latching function) Deviation higher/lower limit value alarm (with latching function)
Action method	ON/OFF

Hysteresis	1 – 9999 unit
Standby action	Selected from between 2 types No standby / standby (when power is applied)
Output type	4a or 2c
Rating	a contact: 240V AC, 2A (resistive load) c contact: 240V AC, 2.5A (resistive load)
Output updating cycle	0.1 seconds
Isolation	a contact: Isolated except for AL1/AL2 and AL3/AL4. c contact: All isolated as well as AL1 and AL2.

Setting range				
	Code	Name	Setting range	Initial value
	HA	Higher limit absolute value alarm	Within range	Range higher limit value
	LA	Lower limit absolute value alarm	Within range	Range lower limit value
	HA_L	Higher limit absolute value alarm (With latching function)	Within range	Range higher limit value
	LA_L	Lower limit absolute value alarm (With latching function)	Within range	Range higher limit value
	So	Scaleover	----	----
	dHi	Deviation higher limit value alarm	-9999 – 19999	19999 unit
	dLo	Deviation lower limit value alarm	-9999 – 19999	-9999 unit
	dHL	Deviation higher/lower limit value alarm	1 – 19999	19999 unit
	dHi_L	Deviation higher limit value alarm (With latching function)	-9999 – 19999	19999 unit
	dLo_L	Deviation lower limit value alarm (With latching function)	-9999 – 19999	-9999 unit
dHL_L	Deviation higher/lower limit value alarm (With latching function)	1 - 19999	19999 unit	

Control input (DI)	
Number of input points	2 points
Type of DI allocation	Selected for each DI from among the following 4 types: Not assigned HLD (Hold): Maintains current input value. RESET: Resets maximum value (MAX) and minimum value (MIN). L_RS: Unlatch
Action input	Non-voltage contact or open collector (level action) Approx. 5V DC
Min. input hold time	0.1 seconds
Isolation	Isolated except for DI and input.

Analog output (optional)	
Type	0 – 10mV (output resistance 10Ω) 0 – 10V (max. load current 2mA) 4 – 20mA (max. load resistance 300Ω)
Resolution	Approx. 1/10000
Output accuracy	±0.1%FS for display value
Scaling	Within measuring range or output range (inverse scaling possible)
Output updating cycle	0.1 seconds
Isolation	Isolation for all

Communication (optional)	
Communication type	RS-232C, RS-485
Communication method	Half duplex start-stop synchronization system
Communication speed	2400, 4800, 9600, 19200 bps
Data format	7E1, 7E2, 7N1, 7N2, 8E1, 8E2, 8N1, 8N2
Communication address	1 – 255
Number of connections	Max. 31 units (RS-485)
Delay	1 – 100 msec
Communication protocol	Shimaden standard protocol, MODBUS ASCII, MODBUS RTU (Shimaden standard protocol offers choice of start character or BCC operating method.)
Isolation	Isolation for all

Sensor power (optional)	
Output rating	24V DC, 50mA (temperature/humidity sensor H71/TH71 Series duplex drive possible)
ON/OFF	According to device ON/OFF
Isolation	Isolation for all

Measuring range codes

1. Multi input

Input type	Code	Measuring range (°C)	Measuring range (°F)	
Thermocouple	B	0.0 – 1800.0	0 – 3300	
	R	0.0 – 1700.0	0 – 3100	
	S	0.0 – 1700.0	0 – 3100	
	K1	-100.0 – 400.0	-150.0 – 750.0	
	K2	0.0 – 400.0	0.0 – 750.0	
	K3	0.0 – 800.0	0.0 – 1500.0	
	K4	0.0 – 1370.0	0.0 – 2500.0	
	K5	-200.0 – 200.0	-300.0 – 400.0	
	E	0.0 – 700.0	0.0 – 1300.0	
	J	0.0 – 600.0	0.0 – 1100.0	
	T	-200.0 – 200.0	-300.0 – 400.0	
	N	0.0 – 1300.0	0.0 – 2300.0	
	PLII	0.0 – 1300.0	0.0 – 2300.0	
	PR40-20	0.0 – 1800.0	0 – 3300	
	WRe5-26	0.0 – 2300.0	0 – 4200	
	U	-200.0 – 200.0	-300.0 – 400.0	
	L	0.0 – 600.0	0.0 – 1100.0	
	K	10.0 – 350.0(K)		
	AuFe-Cr	0.0 – 350.0(K)		
R.T.D.	Pt100	31	-200.0 – 600.0	-300.0 – 1100.0
		32	-100.00 – 100.00	-150.0 – 200.0
		33	-100.0 – 300.0	-150.0 – 600.0
		34	-60.00 – 40.00	-80.00 – 100.00
		35	-50.00 – 50.00	-60.00 – 120.00
		36	-40.00 – 60.00	-40.00 – 140.00
		37	-20.00 – 80.00	0.00 – 180.00
		38	0.000 – 30.000	0.00 – 80.00
		39	0.00 – 50.00	0.00 – 120.00
		40	0.00 – 100.00	0.00 – 200.00
		41	0.00 – 200.00	0.0 – 400.0
		42	0.00 – 300.00	0.0 – 600.0
		43	0.0 – 300.0	0.0 – 600.0
		44	0.0 – 500.0	0.0 – 1000.0
	JPt100	45	-200.0 – 500.0	-300.0 – 900.0
		46	-100.00 – 100.00	-150.0 – 200.0
		47	-100.0 – 300.0	-150.0 – 600.0
		48	-60.00 – 40.00	-80.00 – 100.00
		49	-50.00 – 50.00	-60.00 – 120.00
		50	-40.00 – 60.00	-40.00 – 140.00
		51	-20.00 – 80.00	0.00 – 180.00
		52	0.000 – 30.000	0.00 – 80.00
		53	0.00 – 50.00	0.00 – 120.00
		54	0.00 – 100.00	0.00 – 200.00
		55	0.00 – 200.00	0.0 – 400.0
		56	0.00 – 300.00	0.0 – 600.0
		57	0.0 – 300.0	0.0 – 600.0
		58	0.0 – 500.0	0.0 – 900.0
Voltage (mV)	-10 – 10mV	71	0.00 – 100.00 Scaling possible Scaling range: -9999 - 30000 unit Span: 10 – 40000	
	0 – 10mV	72		
	0 – 20mV	73		
	0 – 50mV	74		
	10 – 50mV	75		
	0 – 100mV	76		
	-100 – 100mV	77		

2. Voltage input

Input type	Code	Measuring range	
Voltage (V)	-1V – 1V	81	0.00 – 100.00 Scaling possible Scaling range: -9999 – 30000 unit Span: 10 – 40000
	0V – 1V	82	
	0V – 2V	83	
	0V – 5V	84	
	1V – 5V	85	
	0V – 10V	86	
	-10V – 10V	87	

3. Current input

Input type	Code	Measuring range	
Current (mA)	0mA – 20mA	94	0.00 – 100.00 Scaling possible Scaling range: -9999 – 30000 unit Span: 10 – 40000
	4mA – 20mA	95	

Accuracy

TC: $\pm(0.1\%FS + 1 \text{ digit})$

Does not however include cold junction temperature compensation error of thermocouple input

Accuracy guarantee not applicable when thermocouple B 400°C or below.

Reading for thermocouple K/T below -100°C: Accuracy $\pm(0.5\%FS + 1 \text{ digit})$

Thermocouple PR40-20: Accuracy $\pm(0.3\%FS + 1^\circ C)$

Thermocouple K

10.0 – 30.0K: Accuracy $\pm(0.75\%FS + 1K)$

30.1 – 70.0K: Accuracy $\pm(0.30\%FS + 1K)$

70.1 – 350.0K: Accuracy $\pm(0.25\%FS + 1K)$

Thermocouple metal / chromel: Accuracy $\pm(0.25\%FS+1K)$

Pt: $\pm(0.1\%FS+0.1^\circ C)$

mV,V: $\pm(0.1\%FS+1\text{digit})$

mA: $\pm(0.1\%FS+1\text{digit})$

Other		
Data storage	Non-volatile memory (EEPROM)	
Operating ambient conditions	Temperature range	-10 – 50°C
	Humidity range	90%RH max. (no dew condensation)
	Altitude range	Elevation: 2000 m max.
	Installation category	II
	Pollution class	2
Storage temperature	-20 – 65°C	
Supply voltage (frequency)	100 – 240V AC±10% (50/60Hz) 24V AC (50/60Hz) /DC±10% (optional)	
Power consumption	13VA (100 – 240V AC) 9VA (24V AC) 7W (24V DC)	
Applicable standards	Safety	IEC61010-1, EN61010-1
	EMC	EN61326: 2006 Display accuracy during EMC test ±3%FS
Dust/drip-proof construction	IP66 equivalent	
Input noise removal ratio	Normal mode min. 50dB (50/60Hz) Common mode min. 120dB (50/60Hz)	
Insulation resistance	500V DC 20MΩ min. between all input/output terminals and power terminals 500V DC 20MΩ min. between all input/output terminals and ground terminals	
Dielectric strength	2300V AC between all input/output terminals and power terminals for 1 minute 1500V AC between power terminals and ground terminals for 1 minute	
Case color/material	Black, Molded PPO resin (equivalent of UL94V-1)	
External dimensions	H48 × W96 × D111 mm (in panel 100 mm)	
Installation	Flush in panel	
Panel thickness	1.0 – 4.0 mm	
Mounting hole dimensions	H45 × W92 mm	
Weight	Approx. 400 g	

The contents of this manual are subject to change without notice.

Temperature and Humidity Control Specialists
SHIMADEN CO., LTD.

Head Office: 2-30-10 Kitamachi, Nerima-ku, Tokyo 179-0081 Japan
Phone: +81-3-3931-7891 Fax: +81-3-3931-3089
E-MAIL: exp-dept@shimaden.co.jp URL: <http://www.shimaden.co.jp>

Printed in Japan