

SR60 (SR62, 63, 64) Series Digital Controller

Instruction Manual

Thank you for purchasing the Shimaden SR60 Series. Please check that the delivered product is the correct item you ordered. Please do not begin operating this product until you have read this instruction manual thoroughly and understand its contents.

Notice

Please ensure that this instruction manual is given to the final user of the instrument.

Preface

This instruction manual is meant for those who will be involved in the wiring, installation, operation and routine maintenance of the SR60 series (SR62, SR63, and SR64).

This manual describes the care, installation, wiring, function, and proper procedures for the operation of SR60 (SR62, SR63, SR64) series. Keep this manual at the work site during operation of the SR60 series. While using this instrument, you should always follow the guidance provided herein.

Contents

1. The Matters regarding Safety.....	2
2. Specifications	3
3. Introduction.....	5
3-1. Check before Use	5
3-2. Handing Instruction.....	5
4. Installation and Wiring.....	5
4-1. Installation Site.....	5
4-2. Mounting	5
4-3. How to Take the Controller out of the Case.....	5
4-4. External Dimensions and Panel Cutout.....	5
4-5. Wiring.....	6
4-6. Terminal Layout	6
4-7. Terminal Arrangement Table	6
5. Names and Functions of Parts.....	6
6. Parameter Operating Procedure, Flow, and Functions	7
6-1. Operating Procedure.....	7
6-2. Parameter Flow and Functions	8
7. Operation.....	10
7-1. Power ON and Initial Screen Display	10
7-2. Function Selection Screen "Mode 2-1"	10
7-3. Measuring Range Scaling "Mode 2-2" (For voltage or current input).....	11
7-4. Setting of set value "Mode 0-0"	12
7-5. Setting of alarm action point "Mode 0-2/0-3" (Optional)	12
7-6. Execution of Auto Tuning (AT) Action	12
7-7. Operation by Manual Control "Mode 0-1"	13
7-8. Setting of Set Value Bias (Sb) "Mode 0-5" (Optional)	13
7-9. Setting of Current Values for Heater Break and Heater Loop Alarms (Optional).....	13
7-10. Operation of Keylock (LOCK) "Mode 1-18".....	14
7-11. Automatic Return of Display Screen.....	14
8. Error Messages.....	14
8-1. Problems with Process Value Input.....	14
8-2. Problems with CT Input for Heater Break Alarm (HB).....	14

1. The Matters regarding Safety

For matters, regarding safety, potential damage to equipment and/or facilities, additional instructions are indicated by the following headings:

⚠WARNING

Exercise extreme caution as indicated. This heading indicates hazardous conditions that could cause injury or death of personnel.

⚠CAUTION

Exercise extreme caution as indicated. This heading indicates hazardous conditions that could cause damage to equipment and/or facilities.

NOTE

This heading indicates additional instructions and/or notes.

The mark \oplus designates a protective conductor terminal. Make sure to properly ground it.

⚠WARNING

SR60 series controller is designed for controlling temperature, humidity and other physical subjects. It must not be used in any way that may adversely affect the safety, health or working conditions of those who come into contact with the effects of its usage. When used, adequate and effective safety countermeasures must be provided at all times. No warranty, express or implied, is valid in the case of using this product without the use of proper safety countermeasures correspondingly.

⚠CAUTION

To avoid damage to the connected equipment, facilities or the product itself due to a fault of the product, safety countermeasure must be taken before usage, such as proper installation of the fuse and the overheating protection device. No warranty, express or implied, is valid in the case of usage without having implemented proper safety countermeasures.

⚠CAUTION

- The \triangle mark on the plate affixed to the instrument: On the terminal nameplate affixed to the case of your instrument, the \triangle mark is printed. This is to warn you of the risk of electrical shock which may result if the charger is touched while it is energized.
- A means to allow the power to be turned off, such as a switch or a breaker, should be installed in the external power circuit to be connected to the power terminal of the instrument.
Fix the switch or the breaker adjacently to the instrument in a position which allows it to be operated with ease, and with an indication that it is a means of turning the power off. The switch or the breaker should meet the requirements of IEC 947.

⚠CAUTION

- Fuse: Since the instrument does not have a built-in fuse, do not forget to install a fuse in the power circuit to be connected to the power terminal.
The fuse should be positioned between the switch or the breaker and the instrument and be attached to the L side of the power terminal.
Fuse Rating: 250V AC 1.0A/medium lagged or lagged type
Use a fuse which meets the requirements of IEC 127.
- Voltage/current of a load to be connected to the output terminal and the alarm terminal should be within a rated range. Otherwise, the temperature will rise and reduce the life of the product and/or result in problems with the product.
For the rated voltage/current, see 2. Specifications on page 12.
The output terminal should be connected with a device which meets the requirements of IEC 1010.
- A voltage/current different from that of the input specification should not be added on the input terminal. It may reduce the life of the product and/or result in problems with the product.
For the rated voltage/current, see 2. Specifications on page 12.
For the rated voltage (mV or V) or current (4~20 mA) input, the input terminal should be connected with a device which meets the requirements of IEC1010 as input terminals.
- As the CT input terminal for the heater break alarm (optional), only the attachment CT should be used. Using anything else may result in problems with the product.
For the CT provided, refer to 3-1. Check before Use on page 14.
- The SR60 series controller is provided with a draft hole for heat discharge. Take care to prevent metal or other foreign matter from obstructing it. Failure to do so may result in problems with the product and may even result in fire.
- Do not block the draft hole or allow dust or the like to adhere to it. Any rise in temperature or insulation failure may result in a shortening of the life of product and/or problems with the product.
For spaces between installed instruments, refer to 4-4. External Dimensions and Panel Cutout on page 3.
- It should be noted that repeated tolerance tests against voltage, noise, surge, etc., may lead to deterioration of the instrument.
- Remodeling the instrument or using it in an anomalous way is prohibited.

2. Specifications

■Display

- Digital display: 7 segments / Measured value (PV)
Red LED 4 digits, Set value (SV)
Green LED 4 digits
- Display accuracy: \pm (1/3% FS+1 digit)
Refer to Table of Measuring Range Codes.
- Display accuracy range: $23 \pm 5^{\circ}\text{C}$
- Display resolution: Depends on measuring range
(0.001, 0.01, 0.1, 1)
- Sampling cycle: 0.25 sec.
- Action display / colors: 7-type LED lamp indication:
Control output (OUT) / Green, Higher limit
alarm action (AH) / Red, Lower limit
alarm action (AL) / Red, Event / Heater
break alarm action (EV/HB) / Red, Auto
tuning (AT) / Green, Manual control
(MAN) / Red, Set value bias (SB) / Green

■Setting

- Setting: By 6 front key switches
- Setting range: Same as the measuring range
- Setting limit: Higher / lower limits individual setting as
desired within measuring range (lower
limit value < higher limit value)

■Input

- Thermocouple: B, R, S, K, E, J, T, N, PL II, WRe 5-26,
{U, L (DIN 43710)}
(Multi input, multi range: Refer to Table of
Measuring Range Codes.)
- External resistance: 100 Ω max.
- Input impedance: 500k Ω min.
- Burnout: Standard feature (up scale)
- Cold junction
temperature
compensation accuracy: $\pm 2^{\circ}\text{C}$ (5~45 $^{\circ}\text{C}$)
- R.T.D.: JIS Pt100 / JPt100 3-wire type
(Multi range: Refer to Table of Measuring
Range Codes.)
- Amperage: Approx. 0.25mA
- Lead wire tolerable
resistance: 5 Ω max. / wire
- Voltage: -10~10, 0~10, 0~20, 0~50, 10~50,
0~100mV DC or -1~1, 0~1, 0~2, 0~5, 1~5,
0~10V DC
(Multi input, programmable range: Refer to
Table of Measuring Range Codes.)
- Input impedance: 500k Ω min.
- Current: 4 ~20, 0~20mA DC
(Multi input, programmable range: Refer to
Table of Measuring Range Codes.)
- Receiving impedance: 250 Ω
- Sampling cycle: 0.25 sec.
- PV bias: -1999~1999 unit
- PV filter: 0~100 sec.
- Isolation: Insulated between input and output (not
insulated between input and system, SV
bias and CT input)

■Control

- Control mode: Auto-tuning PID
- Proportional band (P): Off, 0.1~999.9% FS (Off setting: On-Off
action)
- Integral time (I): 1~6000 sec.
(Off setting: PD, P action)
- Derivative time (D): 0~3600 sec.
(Off setting: PI, P action)
- Manual reset (MR): -50.0~50.0% (valid when I=Off.)
- On-Off hysteresis: 1~999 unit
- Proportional cycle: 1~120 sec.
- Control output
characteristics: RA / DA selectable (set to RA when
shipped)
- Higher and lower output
limit: 0.0~100.0%
(lower limit < higher limit)

■Control Output type / rating

- Contact output (Y1): 240V AC 2.5A / resistive load
- Current output (I1): 4~20mA DC / load resistance: 600 Ω max.
- SSR drive voltage
output (P1): 15 \pm 3V DC / load current: 20mA max.
- Voltage output (V1): 0~10V DC / load current: 2mA max.
- Isolation: Insulated between control output and
system and input (not insulated between
control output I, P, V and analog output)

■Manual control

- Output setting range: 0.0~100.0%
(setting resolution: 0.1%)
Within range of higher / lower output
limits
- Output resolution: 0.5%
- Auto/Manual switching: Balanceless and bumpless (within
proportional band range)

■Alarm Output

- Alarm method: Individual setting and individual output,
higher and lower limit alarms
- Alarm type: Deviation value alarm or absolute value
alarm is selectable.
- Alarm setting range:
Deviation value: Higher limit: 0~5000 unit
Lower limit: -1999~0 unit
When alarm is set beyond higher or lower
limit of measuring range, alarm is activated
at a point 10% beyond higher or lower
limit.
- Absolute value: Higher and lower limits: Within measuring
range
- Alarm action: On-Off action
- Action hysteresis: 1~999 unit (both higher and lower limits)
- Inhibit mode: Selectable (both higher and lower limits)
- Alarm output / rating: Contact 1a (common) / 240 V AC 1.5A
(resistive load)

■Event Output

(Can not be selected when heater break alarm is selected.)

- Number of event outputs: 1 point
- Event type: Selectable from following 8 types
 1. Higher limit deviation value alarm without inhibit action
 2. Lower limit deviation value alarm without inhibit action
 3. Higher limit absolute value alarm without inhibit action
 4. Lower limit absolute value alarm without inhibit action
 5. Higher limit deviation value alarm with inhibit action
 6. Lower limit deviation value alarm with inhibit action
 7. Higher limit absolute value alarm with inhibit action
 8. Lower limit absolute value alarm with inhibit action
- Setting range:
 - Deviation value: Higher limit: 0~5000 unit
Lower limit: -1999~0 unit
When alarm is set beyond higher or lower limit of measuring range, alarm is activated at a point 10% beyond higher or lower limit.
 - Absolute value: Within measuring range of higher and lower limits
- Event action: On-Off action
- Event action hysteresis: 1~999 unit
- Event output / rating: Contact 1a / 240V AC 1.5A (resistive load)

■Heater break alarm

(Can not be selected when event output is selected.)

- Alarm action: Heater amperage detected by externally attached CT (CT provided)
Alarm output On upon detection of heater break while output is On.
Alarm output On upon detection of heater loop alarm while output is Off.
- Current setting range: Off, 0.1~50.0A (Alarm action stops when Off is set.)
- Setting resolution: 0.1A
- Amperage display: 0.0~55.0A
- Display accuracy: 3% FS (when sine wave is 50 Hz)
- Minimum time for action confirmation: On time: 250 msec. minimum
- Alarm output / rating: Contact 1a / 240V AC 1.5A (resistive load)
- Alarm holding: Selectable
- Sampling cycle: 0.5 sec.
- Isolation: Insulated between CT input and output (not insulated between CT input and system and other inputs)

■Analog output

- Number of analog outputs: 1 point
- Analog output type: Selectable between process value (PV) and set value (SV)

- Analog output: 0~10mV DC, Output resistance: 10Ω
0~10V DC, Load current: 2mA max.
4~20mA DC, Load resistance: 300Ωmax.
- Output accuracy: $\pm 1/3\%$ (of displayed value)
- Output resolution: Approx. 0.0125% (1/8000)
- Output updating cycle: 0.25 sec.
- Output scaling: Within measuring range
- Isolation: Insulated between analog output and system and input (not insulated between analog output and control output I, P, V)

■Set value Bias

- Setting range: -1999~5000 unit
- Setting resolution: Same as display resolution
- Action input: Non-voltage contact (bias in action when input is closed)
- Isolation: Insulated between the set value bias input and output (not insulated between set value bias input and system and other inputs)

■Safety and EMC requirements

- Safety : IEC1010-1, EN61010-1
- EMC: EMI (emission) EN50081-1
EMS (immunity) EN50082-2

■Others

- Data storage: By non-volatile memory (EEPROM)
- Operating ambient temperature/humidity range: -10~50°C / 90% RH max. (no dew condensation)
- Supply voltage: 100 – 240V AC $\pm 10\%$ (50 / 60 Hz), 24V AC $\pm 10\%$ (50/60Hz) or 24V DC $\pm 10\%$
- Power consumption: SR62, SR63, SR64:Max. 10VA(AC),6W (DC)
- Insulation resistance: Between input / output terminal and power supply terminal: 500V DC 20 MΩ minimum
Between input / output terminal and ground terminal: 500V DC 20 MΩ minimum
- Dielectric strength: 1 min. at 2300V AC between input / output terminal and power supply terminals
1 min. at 1500V AC between power supply terminal and ground terminal
- Protective structure: Only front panel has simple dust-proof and drip-proof structure
- Material: PPO resin molding (equivalent to UL94V-1)
- External dimensions: SR62: H72 × W72 × D110 (panel depth: 100) mm
SR63: H96 × W96 × D70 (panel depth: 60) mm
SR64: H96 × W48 × D110 (panel depth: 100) mm
- Mounting: Push-in panel (one-touch mount)
- Panel thickness: 1.0~3.5 mm
- Panel cutout: SR62: H68 × W68mm
SR63: H92 × W92mm
SR64: H92 × W45mm
- Weight: SR62: Approx. 290g
SR63: Approx. 310g
SR64: Approx. 280g

3. Introduction

3-1. Check before Use

This product has been fully checked for quality assurance prior to shipment. Nevertheless, you are requested to make sure that there is no error, damage or shortage of delivered items by confirming the model codes and checking the external view of the product and the number of accessories.

Confirmation of Model Codes:

Check the model codes stuck to the case of the product to ascertain if respective codes designate what was specified when you ordered the product, referring to the following code table:

Item	Code and Description
1. Series	SR62, SR63, SR64
2. Input	1: Thermocouple 2. R.T.D. 3. Voltage (mV) 4. Current (mA) 6. Voltage (V)
3. Control output	Y1: Contact I1: Current P1: SSR drive voltage V1: Voltage
4. Power supply	90: 100~240V AC 10: 24V AC 02:24V DC
5. Alarm/event/ heater break alarm (Heater break alarm can be selected if Y1 or P1 is selected for item 3 above.)	00: Without 03: Higher/lower limit alarm 12: Higher/lower limit alarm + event output 13: Higher/lower limit alarm + heater break alarm (30A) 14: Heater break alarm (30A) 15: Higher/lower limit alarm + heater break alarm (50A) 16: Heater break alarm (50A)
6. Analog output	0: Without 3: Voltage (mV) 4: Current (mA) 6: Voltage (V)
7. Set value bias	0: Without 1: With
8. Remarks	C: Without (CE marking) 9: With

Accessories to be checked:

Instruction manual 1 set
Unit decal 1 sheet

Current transformer (CT) for heater break alarm: included with the heater break alarm option

TYPE CTL-6-S for 30A selection
TYPE CTL-12-S36-8 for 50A selection

Note: Contact our representative concerning any problems with the product, accessories or related items.

3-2. Handling Instructions

- Do not operate the keys on the front panel with a hard or sharply pointed object. Operate the keys only by softly touching them with your finger tips.
- When cleaning the controller, wipe it softly with a dry cloth. Never use solvent such as thinner or the like.

4. Installation and Wiring

4-1. Installation Site

⚠ CAUTION

When selecting a site for the controller, avoid the places mentioned below. Selection of these places may result in a malfunction or damage to the controller, including the worse case of fire, depending on the circumstances.

- Where flammable gas, corrosive gas, oil mist and particles that can deteriorate electrical insulation are generated or are abundant.
- Where the temperature is below -10°C or above 50°C.
- Where the relative humidity is 90%RH or below dew point.
- Where highly intense vibration or impact is generated or transferred.
- Near high voltage power lines or where inductive interference can affect the operation of the product.
- Dew drops or direct exposure to sun light.
- Where the elevation is in excess of 2,000 m.

Note: The environmental conditions belong to the installation category II of IEC 664 and the degree of pollution is 2.

4-2. Mounting

- Cut a hole for mounting the controller in the panel with reference to the cutout drawing shown in section 4-4 on page 3.
- The panel thickness should be 1.0~3.5 mm.
- As the instrument is provided with pawls for fixing, mount it by pressing it firmly from the front of the panel.

4-3. How to Take the Controller out of the Case

⚠ CAUTION

When taking the controller out of the housing or reassembling it in place, make sure the power supply is switched off. If the power is not switched off, a malfunction or damage to the controller may result.

Under ordinary circumstances, the SR 60 series controller need not be taken out of its housing. However, if such a step is necessary for the purpose of replacement or the like, follow the procedure described below. Insert a screwdriver with a tip width of 6 to 9 mm into a notch (where the packing is exposed) on the bottom of the casing and rotate the screw driver while pressing up the lock lever behind the packing. When the controller body comes out of the housing by a few mm, use your hand to pull it out completely.

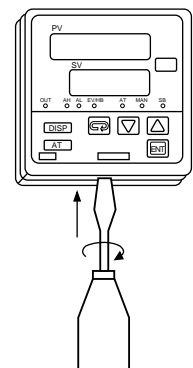

4-4. External Dimensions and Panel Cutout

Please refer to section 4-4 on page 3.

4-5. Wiring

⚠ WARNING

- When wiring, make sure to disconnect the power supply. Otherwise an electric shock may result.
- Make sure the protective conductor terminal (⊕) is grounded. Otherwise an electric shock may result.
- Do not touch terminals or other charged elements with power supplied after wiring.

- (1) Follow the terminal layout shown in section 4-6 and make sure to carry out the correct wiring.
- (2) Press-fit terminal must fit an M3.5 screw and have a width of 7 mm or smaller.
- (3) In the case of the thermocouple input, use a compensating conductor compatible with the type of thermocouple selected.
- (4) In the case of R.T.D. input, the resistance of a single lead wire must be 5Ω or less and the three wires must have the same resistance value.
- (5) The input signal wire must not be accommodated with a high-voltage power cable in the same wiring conduit or duct.
- (6) Shielded wire (one-point grounding) is effective to avoid electrostatic induction noise.
- (7) An effective way to avoid magnetic induction noise is to twist the input wires at short and equal intervals.
- (8) The wiring for power supply must be a 600V vinyl insulated wire or cable having a cross-section area of 1 mm² or larger or a wire or cable of the same or better performance.
- (9) The wire for grounding must be larger than 2 mm² and must be grounded at a grounding resistance of 100Ω or lower.
- (10) Noise filter

If the instrument appears to have noise interference caused by the power supply, use a noise filter to prevent erroneous functioning.

Install a noise filter on the grounded panel and make the wire connecting the noise filter OUT terminal and the power supply terminal on the controller as short as possible.

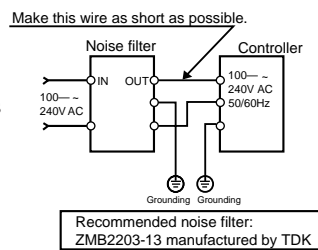

4-7. Terminal Arrangement Table

Name of terminal	Description	Terminal No.		
		SR62	SR63	SR64
Power supply terminal	100-240V AC, 24V DC, or 24V AC	8-9	11-12	11-12
Protective conductor terminal	⊕	10	13	13
Input terminal	R.T.D.: A, Thermocouple, voltage, current: +	5	8	8
	R.T.D.: B	6	9	9
	R.T.D.: B, Thermocouple, voltage, current: -	7	10	10
Control output terminal	Contact: COM, SSR drive voltage, voltage, current: +	11	14	14
	Contact: NO, SSR drive voltage, voltage, current: -	12	15	15
	Contact: NC	13	16	16
Alarm output terminal	Contact: COM	17	18	18
	Contact: AL (lower limit)	18	19	19
	Contact: AH (higher limit)	19	20	20
Heater break alarm CT input terminal		3-4	6-7	6-7
Set value bias input terminal		1-2	4-5	4-5
Event/heater break alarm output terminal	Contact: NO	20-21	29-30	23-24
Analog output terminal	Voltage or current	15-16	21-22	21-22

5. Names and Functions of Parts

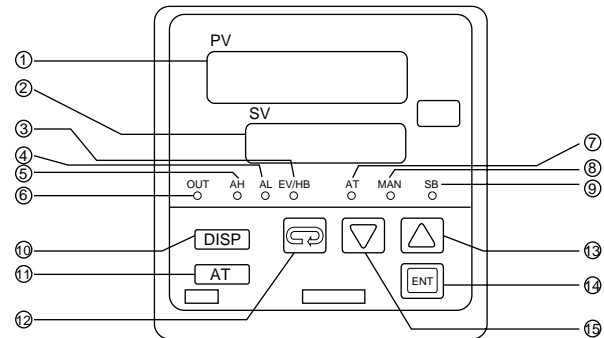

4-6. Terminal Layout

SR62

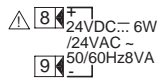

SR63

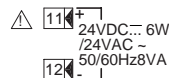
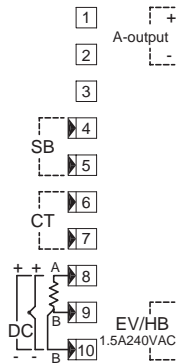



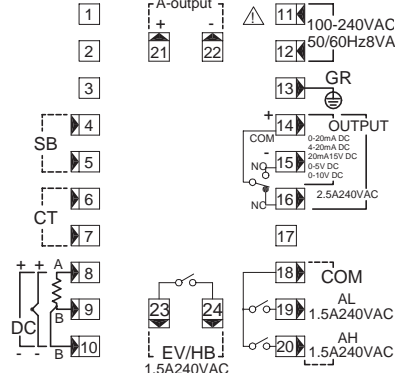
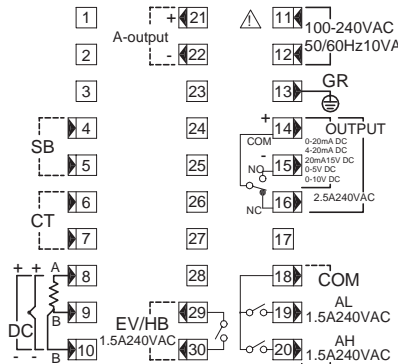
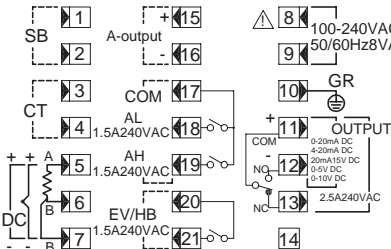
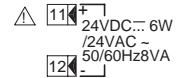



SR64



■Display Section

- ① Process value (PV) display / red
Process values (PV) are displayed. When a parameter is set, its type is displayed.
When something goes out of order in the system, an error message is displayed.
- ② Set set value (SV) display / green
Set set value are displayed. When a parameter is set, its value is displayed.
- ③ Event / HB lamp (EV/HB) / red
The lamp lights when event output is on or heater break / heater loop alarm output is on.
- ④ Lower limit alarm lamp (AL) / red
The lamp lights when lower limit alarm output is on.
- ⑤ Higher limit alarm lamp (AH) / red
The lamp lights when higher limit alarm output is on.
- ⑥ Output lamp (OUT) / green
The lamp lights when control output is on and its brightness changes in proportion to the amount of output in the case of current output and voltage output.
- ⑦ Auto tuning lamp (AT) / green
The lamp lights while auto tuning is in progress and remains lit while standing by for AT action.
- ⑧ Manual control lamp (MAN) / red
The lamp flashes while in the manual control mode.
- ⑨ Set value bias lamp (SB) / green
The lamp lights while the set value bias action is in progress.







■Setting Section

- ⑩ Display key 
When this key is pressed in any of the parameter screens, the display returns to the display / set value screen.
Pressing it for 5 seconds brings the initial value setting screen (mode 2) on display.
- ⑪ Auto tuning key 
This key is used to execute and stop auto tuning action.
- ⑫ Parameter key 
This key is used to select a parameter to be set or changed. Press it for 3 seconds to move to the parameter block in mode 1.
- ⑬ Up key 
The flashing of the decimal point in the lowest place on the SV display shows that the value is ready to be changed. Press this key to increase a numeric data or to change selected character data.
- ⑭ Enter key 
This key is used to register a changed data (the decimal point in the lowest place flashes.) Once registered, the decimal point stops flashing. If this key is pressed for 3 seconds on the output screen (0-1), the mode changes to manual control.
- ⑮ Down key 
The flashing of the decimal point on the lowest place on the SV display shows that the value is ready to be changed. Press this key to decrease a numeric data or to change selected character data.





6. Parameter Operating Procedure, Flow, and Functions

6-1. Operating Procedure





(Parameter Flow and Functions are shown in section 6-2.)

- (1) Turn on the power supply to display the "Mode 0-0" basic screen.
- (2) The "Mode 0-0" basic screen displays the process value (PV) and the set value (SV) which are the starting points of the respective parameters.
- (3) In order to move to the "Mode 1" screen group, press the  key for 3 seconds or longer on the "Mode 0-0" basic screen.
- (4) In order to move to the "Mode 2" function selection mode screen group, press the  key for 5 seconds or longer on the "Mode 0-0" basic screen.
- (5) In order to move from one screen to another within each screen group, press the  (parameter) key.
- (6) If you select a desired screen No. to be called within the "Mode 1" group on the first screen (Mode 1-0) in the "Mode 1" screen group, you can move directly to that screen (direct call).
- (7) Use the  &  keys to set the value on each screen (the decimal point in the lowest place keeps flashing during the value setting procedure) and press the  key to register the value.
- (8) The "Mode 0-0" basic screen can be accessed from any screen by pressing the  key.

"Mode 0" Operation Parameter Screen Group (Setting of the set value, alarm/event action point, Sb, P, I, D)

- This screen group is subject to the most frequent setting modification.
- Press the  key to move to "Mode 0-1" from the "Mode 0-0" basic screen.
- Press the  key to move to the next screen within the screen group.
- Use the  &  keys to set the value on each screen (the decimal point in the lowest place keeps flashing during the value setting procedure) and press the  key to register the value.

"Mode 1" Operation Parameter Screen Group (Setting the value for each function)

- This screen group is not often subject to frequent setting modification.
- Press the  key for 3 seconds or longer to move to "Mode 1-0" from the "Mode 0-0" basic screen.
- Press the  (parameter) key to move from one screen to another within the screen group.
- Use the  &  keys to set the value on each screen (the decimal point in the lowest place keeps flashing during the value setting procedure) and press the  key to register the value.

"Mode 2" Function Selection Screen Group

- This group is used to select functions.
- Press the  key for 5 seconds or longer to move to "Mode 2-1" from the "Mode 0-0" basic screen.
- For the operating procedure on each screen, refer to section 7 "Operation" on page 19.

6-2. Parameter Flow and Functions

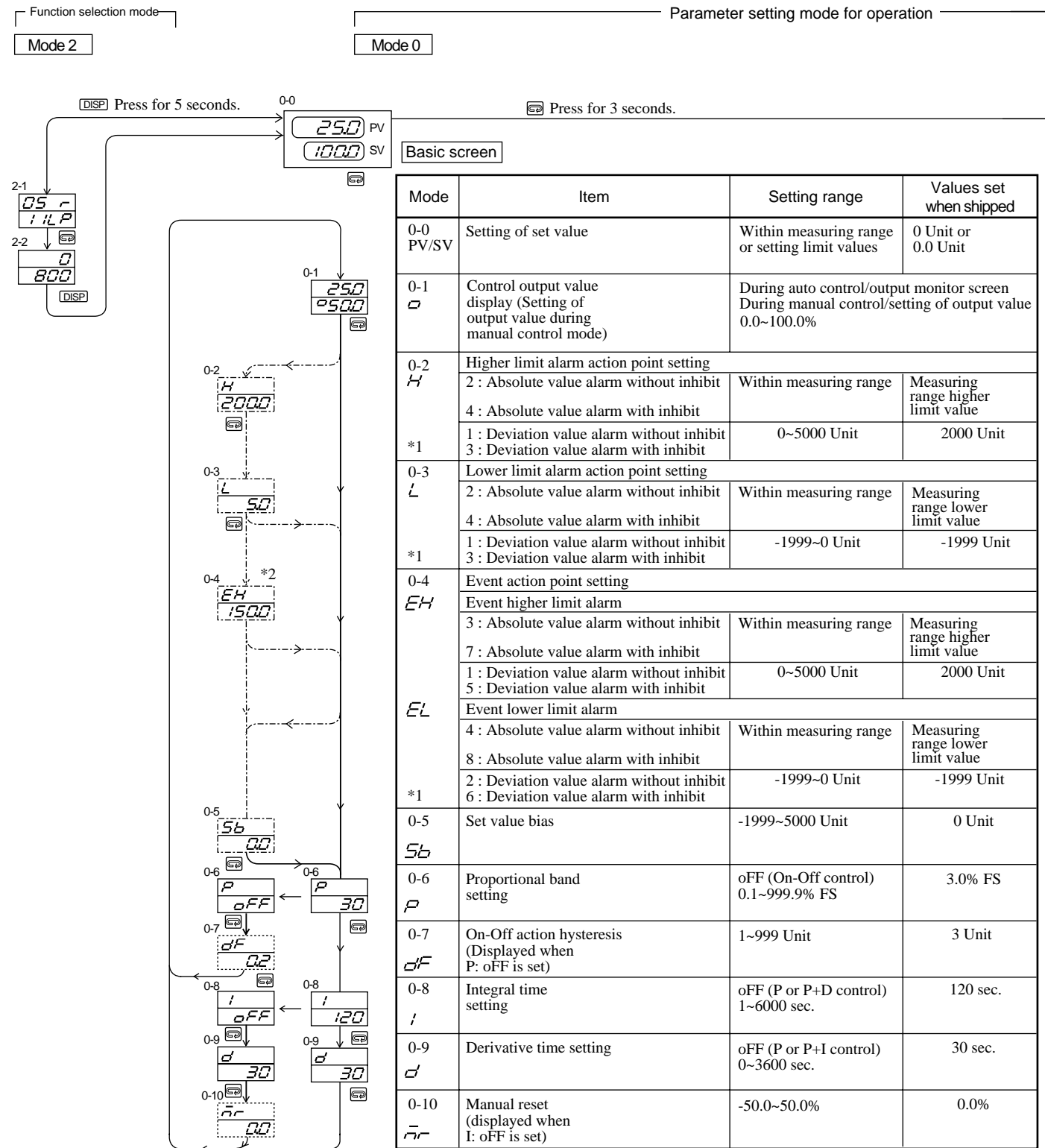

Standard function parameter

Parameter displayed depending upon setting the conditions of the standard function parameter

Optional function parameter
This parameter is not displayed when no optional function is set.

*1 In Alarm/Event action point setting, decimal point are placed according to measuring range.

*2 Either higher limit or lower limit is shown, which you selected.

NOTE : In case types of Alarms / Events are changed, values are initialized.

mode 1

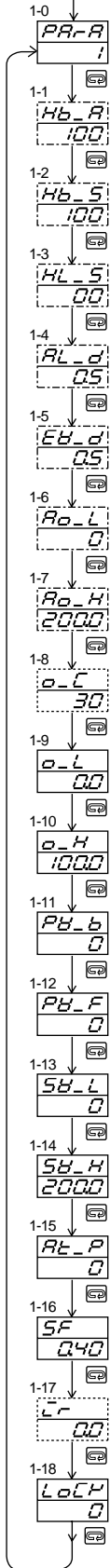

Name of screens and mode No.	Setting range Numbers in () shows values set before shipping	Function description
Direct call execution screen 1-0	1~18 (1)	For the quick selection of a desired parameter, set the parameter mode No., the desired parameter No. out of 1 through 18 on the SV display of the "Mode 1-0" (PARA) which is the first screen of the "Mode 1" group, then, press the ENT key.
Heater current monitor screen 1-1 (Option)		This screen is for reading current only. You cannot set the value.
Heater break alarm value setting screen 1-2 (Option)	oFF, 0.1~50.0A (oFF)	Detects the heater current by the function of the CT when the control output is on and outputs an alarm if the current is lower than the set current value judged as being an abnormal condition.
Heater loop alarm value setting screen 1-3 (Option)	oFF, 0.1~50.0A (oFF)	Detects the heater current by the function of the CT when the control output is off and outputs an alarm if the current is higher than the set current value as judged by an abnormal loop condition in the output circuit.
Alarm action hysteresis setting screen 1-4 (Option)	1~999 Unit (5 Unit)	Sets the action hysteresis of the alarm relay ON action position and OFF action position.
Event action hysteresis setting screen 1-5 (Option)	1~999 Unit (5 Unit)	Sets the action hysteresis of the event relay ON action position and OFF action position.
Analog output higher limit side scale setting 1-6 (Option)	Within measuring range (Lower limit value of measuring range)	Sets the lower limit side scale value for output value 0%.
Analog output higher limit side scale setting 1-7 (Option)	Within measuring range (Higher limit value of measuring range)	Sets the higher limit side scale value for output value 100%.
Proportional cycle time setting 1-8	1~120 sec. (30 sec.)	Average proportional cycle time is 30 seconds when the control output is set at contact (Y) and approximately 3 seconds when the control output is set at SSR drive voltage (P).
Lower output limiter setting (control output) 1-9	0.0~99.9% (0.0%) o_L<o_H	By setting the limit values of the control output in advance, the max. and min. values of the control output remain within the limit values. *The lower limit may be used to secure the minimum temperature and the higher limit. The upper limit can be used for the prevention of overshooting.
Higher output limiter setting (control output) 1-10	0.1~100.0% (100%) o_L<o_H	
Process value bias setting 1-11	-1999~1999 Unit (0 Unit)	If a temperature gap is observed due to the temperature within the furnace to be controlled and the position of the detector, setting the gap (process value bias) allows display and execution of control with the "process value (PV) + process value bias (PV_b)" as the measured input value.
Process value filter setting 1-12	0~100 sec. (0 sec.)	When the process value input contains noise, the display of the process value and the result of the control operation may be affected. In order to minimize such influence, a time constant is set. * The larger the time constant is, the greater the effect of removing noise
Lower limit side set value limiter setting 1-13	Within measuring range (Lower limit value of measuring range) SV_L<SV_H	Setting the limit values of the set value range in advance will result in the values being limited within the set limit range.
Higher limit side set value limiter setting 1-14	Within measuring range (Higher limit value of measuring range) SV_L<SV_H	
AT execution point setting 1-15	0~5000 Unit (0 Unit)	When executing AT action, if you want to avoid hunting due to a limit cycling at a set set value, set a hypothetical SV so as to execute AT action at a point apart from the actual set set value.
Set value point setting (not displayed when P:OFF, I:OFF.) 1-16	oFF, 0.01~1.00 (0.40)	This function is used to adjust overshooting or undershooting at a set value by using the control result as a guideline in PID control mode. The control of overshooting is the most effective when SF is at 1.00.
Initial reset setting 1-17	-50.0~50.0% (0.0%)	
Keylock setting 1-18	oFF, 1~3 (oFF)	This function locks the key operation. It can be used to prevent erroneous key operation after completing the setting of various data.

If a mode No. for which no optional function is assigned is selected, the mode of the following No. is selected.

7. Operation

7-1. Power ON and Initial Screen Display

When power is supplied, a selected function is displayed on the screen as shown below. Then, in about 3 seconds, the "Mode 0-0" basic screen is displayed.

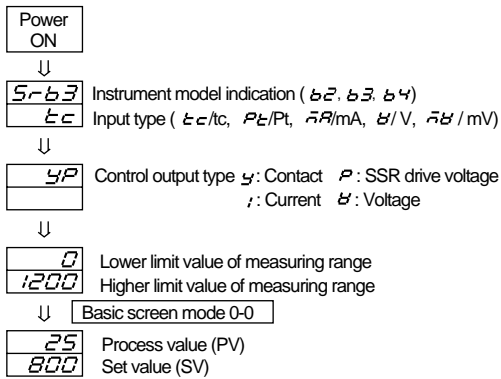

This controller series is designed for multi-range or programmable range operation. The controller is set as follows at our plant before shipping.

Values set before shipping:

Input	Standard / Rating	Measuring Range
1. Thermocouple	JIS K	0 ~ 800 °C
2. R.T.D.	JIS Pt100	0.0 ~ 200.0 °C
3. Voltage (mV)	0~10mV DC	0.0 ~ 100.0 No-legend
4. Current (mA)	4~20mA DC	0.0 ~ 100.0 No-legend
6. Voltage (V)	1~5V DC	0.0 ~ 100.0 No-legend

7-2. Function Selection Screen "Mode 2-1"

"Mode 2-1" is the screen used to select such functions as measuring range, control action (RA/DA) and other optional functions, including alarms, events, heater break alarm (HB), and analog output.

Press the **[DISP]** key for 5 seconds in the "Mode 0-0" screen to call up the "Mode 2-1" screen. The decimal point shown in ② flashes to show that number is ready to be changed.

If you want to change it, select a measuring range code (see the attached table) using the **[Δ]** & **[▽]** keys and register it using the **[ENT]** key. When there is no need to change it, press the **[ENT]** key.

The decimal point in ④ begins flashing to show that the control action mode (RA/DA) is ready to be selected.

In this way, press the **[ENT]** key to move the flashing decimal point to the desired position and change the other set conditions by pressing the **[Δ]** & **[▽]** keys and register it by pressing the **[ENT]** key.

Every time the **[ENT]** key is pressed, the flashing decimal point showing readiness to be changed moves to the following item in the sequence of ①, ② through ④ and ⑤ and finally to ⑧. When you have finished changing, press the **[DISP]** key to move to the "Mode 0-0" basic screen.

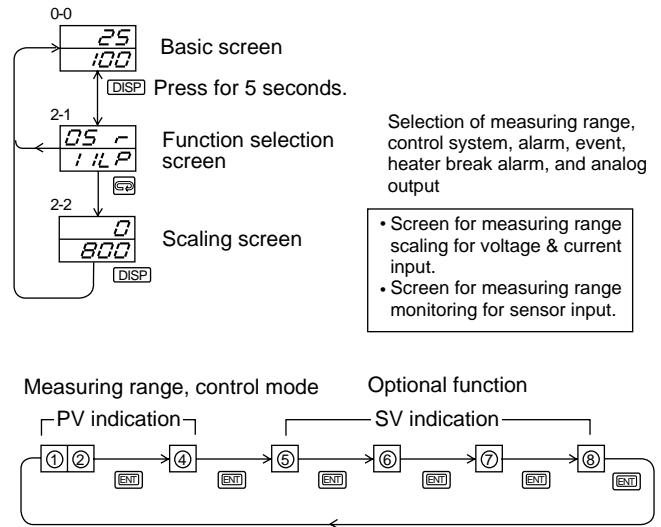

• Indication No. ①, ② Selection of Measuring Range Table of Measuring Range Codes

	Input type	Code	Measuring Range	Code	Measuring Range
Thermocouple	*1 B	01	0 ~ 1800°C	15	0 ~ 3300°F
	R	02	0 ~ 1700°C	16	0 ~ 3100°F
	S	03	0 ~ 1700°C	17	0 ~ 3100°F
	K	04	-100.0 ~ 400.0°C	18	-150 ~ 750°F
		05	0 ~ 800°C	19	0 ~ 1500°F
		06	0 ~ 1200°C	20	0 ~ 2200°F
		E	07	0 ~ 700°C	21
	J	08	0 ~ 600°C	22	0 ~ 1100°F
	T	09	-199.9 ~ 200.0°C	23	-300 ~ 400°F
	N	10	0 ~ 1300°C	24	0 ~ 2300°F
	*2 PLII	11	0 ~ 1300°C	25	0 ~ 2300°F
	*3 WRe5-26	12	0 ~ 2300°C	26	0 ~ 4200°F
	*4 U	13	-199.9 ~ 200.0°C	27	-300 ~ 400°F
	*4 L	14	0 ~ 600°C	28	0 ~ 1100°F
R.T.D.	Pt	31	-200 ~ 600°C	47	300 ~ 1100°F
	Pt	32	-100.0 ~ 100.0°C	48	-150.0 ~ 200.0°F
	Pt	33	-100.0 ~ 300.0°C	49	-150 ~ 600°F
	Pt	34	-50.0 ~ 50.0°C	50	-50.0 ~ 120.0°F
	Pt	35	*5 0.0 ~ 50.0°C	51	0.0 ~ 120.0°F
	Pt	36	0.0 ~ 100.0°C	52	0.0 ~ 200.0°F
	Pt	37	0.0 ~ 200.0°C	53	0.0 ~ 400.0°F
	Pt	38	0.0 ~ 500.0°C	54	0 ~ 1000°F
	JPt	39	-200 ~ 600°C	55	-300 ~ 1100°F
	JPt	40	-100.0 ~ 100.0°C	56	-150.0 ~ 200.0°F
	JPt	41	-100.0 ~ 300.0°C	57	-150 ~ 600°F
	JPt	42	-50.0 ~ 50.0°C	58	-50.0 ~ 120.0°F
	JPt	43	*5 0.0 ~ 50.0°C	59	0.0 ~ 120.0°F
	JPt	44	0.0 ~ 100.0°C	60	0.0 ~ 200.0°F
JPt	45	0.0 ~ 200.0°C	61	0.0 ~ 400.0°F	
JPt	46	0.0 ~ 500.0°C	62	0 ~ 1000°F	
mV	-10 ~ 10mV	71	The scaling function in the measuring range allows the selection of anything within the following range.		
	0 ~ 10mV	72			
	0 ~ 20mV	73			
	0 ~ 50mV	74			
	10 ~ 50mV	75			
	0 ~ 100mV	76			
V	-1 ~ 1V	81	Scaling range -1999~9999 count Span 100~5000 count		
	0 ~ 1V	82			
	0 ~ 2V	83			
	0 ~ 5V	84			
	1 ~ 5V	85			
	0 ~ 10V	86			
mA	0 ~ 20mA	94			
	4 ~ 20mA	95			

- *1 Thermocouple B: Accuracy guarantee not applicable to 400°C to 750°F and below.
- *2 Thermocouple PLII: Platinel
- *3 Thermocouple WRe5-26: Made by Hoskins
- *4 Thermocouple U, L: DIN43710
Thermocouple B, R, S, K, E, J, T, N: JIS / IEC
- *5 R.T.D.: Accuracy $\pm 0.3^\circ\text{C}$ ($\pm 0.8^\circ\text{F}$)

In case measuring range is modified, set values, alarm action point and other related values are all initialized.

R.T.D. JPt100: (Old) JIS
R.T.D. Pt100: (New) JIS/IEC

• Indication No. ④ Selection of Output Action Characteristics (selection between RA / DA)

Either of the control output action characteristics, DA (direct action) or RA (reverse action), is set. DA (direct action) means that the lower the control output falls, the more the process value (PV) drops below the set value (SV). DA is generally used for cooling control. RA (reverse action) means that the more the process value (PV) drops below the set value (SV), the higher the control output rises. RA is used for heating control.

- ▷ [d]: DA (direct action for cooling control)
- ▷ [r]: RA (reverse action for heating control) (initial value)

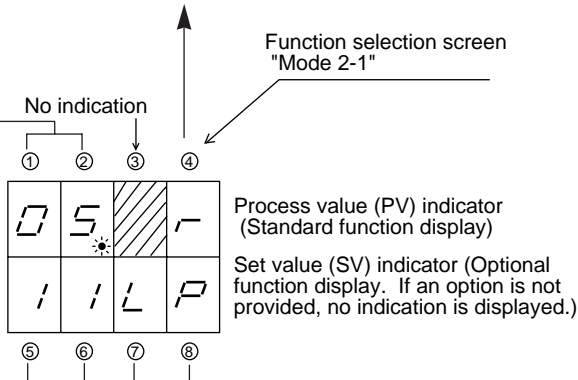

• Indication No. ⑧ Selection of Analog Output Type (P/S) (Optional)

- P (P): Process value (PV) output (Initial value)
- S (S): Set value (SV) output

Either the process value (PV) or set value (SV) can be selected as analog signal output. The scaling is carried out on the 1-6 and 1-7 screens of "Mode 1" groups screens.

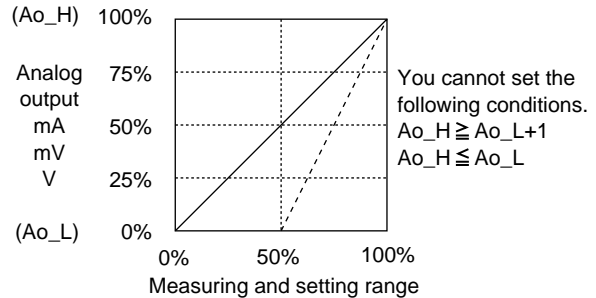

7-3. Measuring Range Scaling "Mode 2-2"
(For voltage or current input)

Measuring range scaling function allows a setting within the following range.

Scaling range: -1999~9999 counts

Span: 100~5000 counts

Initial values	Lower limit value:	0.0
	Higher limit value:	100.0

• Indication No. ⑤ Selection of Types of Alarms (Optional)

- Selectable types 1~4 (Initial value : 1)
- 1: Deviation value alarm (without inhibit action)
 - 2: Absolute value alarm (without inhibit action)
 - 3: Deviation value alarm (with inhibit action)
 - 4: Absolute value alarm (with inhibit action)

• Indication No. ⑥ Selection of Types of Events (Optional)

- Selectable types 1~8 (Initial value: 1)
- 1: Higher limit deviation value alarm (without inhibit action)
 - 2: Lower limit deviation value alarm (without inhibit action)
 - 3: Higher limit absolute value alarm (without inhibit action)
 - 4: Lower limit absolute value alarm (without inhibit action)
 - 5: Higher limit deviation value alarm (with inhibit action)
 - 6: Lower limit deviation value alarm (with inhibit action)
 - 7: Higher limit absolute value alarm (with inhibit action)
 - 8: Lower limit absolute value alarm (with inhibit action)

• Indication No. ⑦ Selection of Heater Break Alarm (HB) (Optional)

Selection between

- ∟ (L) Lock Mode (Initial value)
- ▷ (r) Real mode

∟ (L) Lock Mode

Once an alarm is output, the alarm output is locked. If the current returns to the normal range, the alarm output cannot be released before 'oFF' is set for the alarm value or power supply to the instrument is turned off.

▷ (r) Real mode

In the real mode, an alarm is output when the current goes out of the permissible range. The alarm is released when the current returns to the normal range.

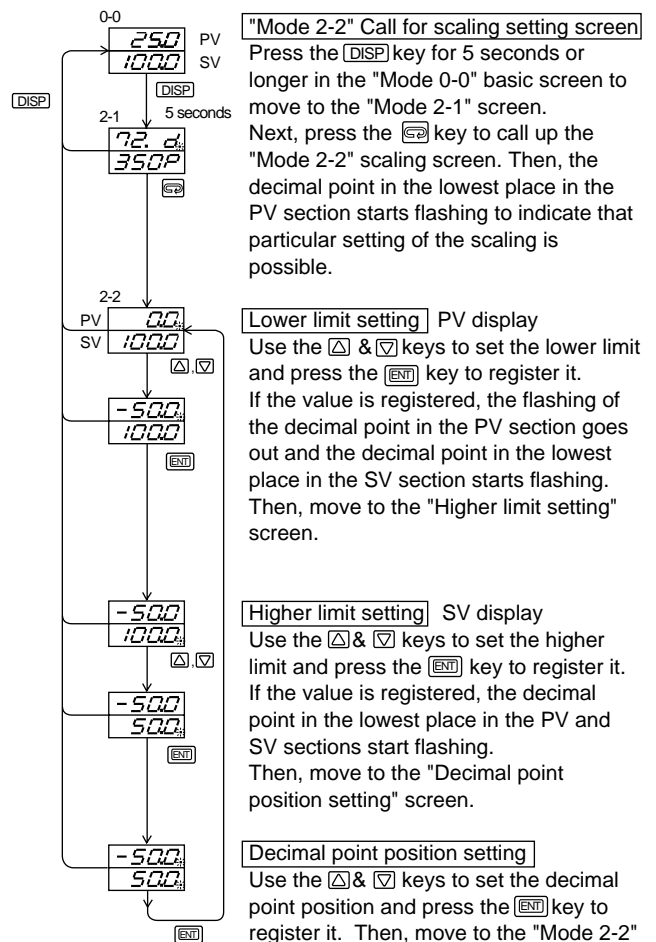

7-4. Setting of set value "Mode 0-0"

- (1) After supplying power, confirm that the "Mode 0-0" basic screen is displayed.
- (2) Use the Δ & ∇ keys to set the set value while checking the SV display. Then, the decimal point in the lowest place in the SV display starts flashing.
- (3) Press the ENT key to register the set value. Then, the flashing of the decimal point goes out and the setting of the set value is completed.

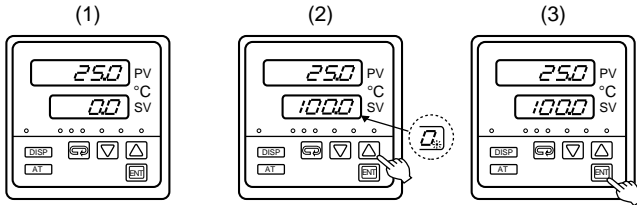

• Operating procedure

- (1) Press the AT key in the basic screen during operation to establish auto tuning standby condition. Then, the AT lamp lights up.
- (2) Press the ENT key to execute AT action. Then the AT lamp goes out indicating that the AT action is being executed.
- (3) When the AT action is completed, the control action with new PID constants starts. Then the AT lamp goes out.

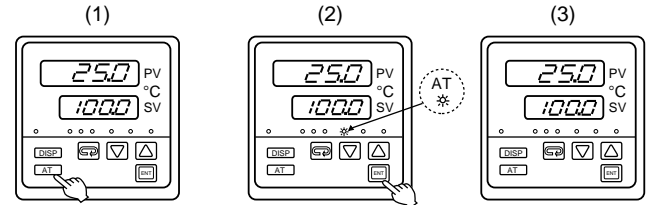

7-5. Setting of alarm action point "Mode 0-2/0-3" (Optional)

- (1) Press the G key twice in the basic screen to display the higher limit alarm (H) parameter or three times to display the lower limit alarm (L) parameter.
- (2) Use the Δ & ∇ keys to set the alarm action point value while checking the SV display. Then, the decimal point in the lowest place in the SV display starts flashing.
- (3) Press the ENT key to register the alarm action point value. Then, the flashing of the decimal point goes out.
- (4) Press the DISP key to go back to the basic screen.

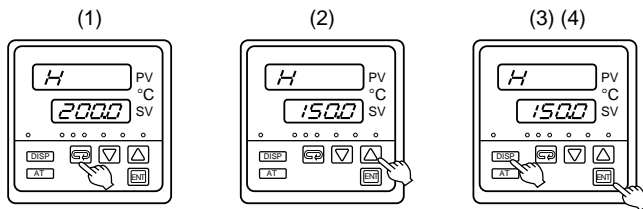

To Stop Auto Tuning in the Execution

Press the AT key and then the ENT key. The AT lamp goes out and auto tuning action is released.

In this case, PID values return to those before the start of auto tuning.

Auto tuning cannot be done in the following cases:

- While manual control is on
- When the input value is out of the measuring range
- When the proportional band is set at P=Off (On-Off control)
- If the ENT key is not pressed within 5 seconds during standby (AT lamp flashing) for AT
- When the H side output limiter differs from the L side one by 20% or less

Restrictions on Execution of Auto Tuning

- If the process value gets overscale, AT is forced to end.
- While auto tuning is on, no settings can be changed except the alarm or event setting.
- While auto tuning is on, manual control cannot be turned on.
- While auto tuning is on, the set value bias (SB) is maintained at the value before the start of auto tuning. A change of SB input becomes valid only when the auto tuning action ends.
- If the auto tuning action exceeds 200 minutes, it is forced to stop and PID values before the start of AT are used.

7-6. Execution of Auto Tuning (AT) Action

Auto tuning functions to automatically measure, compute, and set optimum constants in PID control.

Auto tuning can be executed in any of the following states: immediately upon supplying power, while temperature is rising, and during stable control.



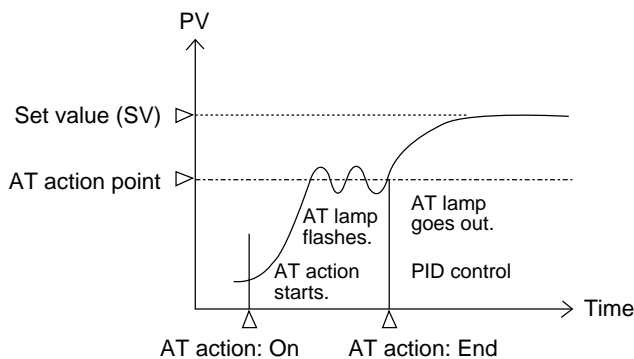



Execution of Auto Tuning (Upon Activation)





7-7. Operation by Manual Control "Mode 0-1"

Changing to manual control mode

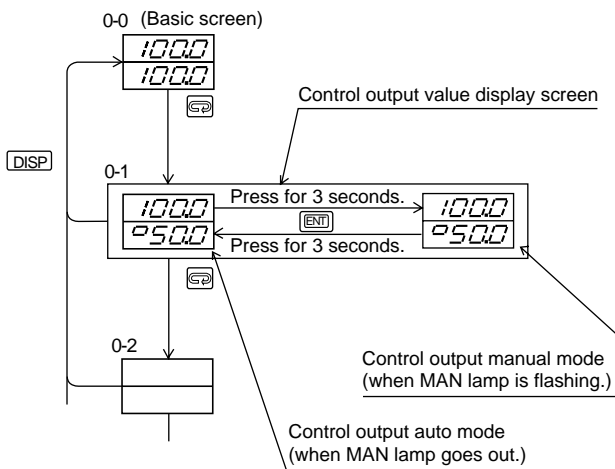

Changing to control output manual mode and setting of manual control output value is operated in the control output value display (Mode 0-1). In addition, operation to return to the auto mode from the manual mode is done in the mode 0-1 screen.

- Press the  key in the basic screen (0-0) to call up the mode 0-1 screen. Then, the control output value is displayed in the SV display.
- Next, press the  key for 3 seconds to start the flashing of the manual control action indicator lamp (MAN lamp) and control output manual mode is established. Use the  &  keys to change the output value setting. After that, the changed value is displayed.
- Even in the manual mode, you can move to another screen (or screen group) by pressing the  key and/or the  key. Note that the control output is set to be activated manually at this moment. (The manual mode is selected if the MAN lamp is flashing.)
- In order to release the control output manual mode (when the MAN lamp is flashing), press the  key for 3 seconds in the mode 0-1 screen. Then, the MAN lamp goes out and the mode changes to control output auto mode.



Note: Even in the manual mode, you can move to another screen (or screen group) by pressing the  key and/or the  key. Note that the control output is set to be activated manually at this moment. The manual mode is selected if the manual (MAN) lamp is flashing.

* Restrictions on Manual Control

- The manual control action and output value remain stored even when power is turned off and then on again.
- When the measuring range is changed, the manual control mode is released and the automatic control mode returns.
- When switching from the auto to the manual mode, the action becomes balanceless and bumpless. This does not happen, however, if the process value (PV) is out of the proportional band at the time of mode switching.
- The selectable range of control output in the manual control mode is within the limit range of output limiters. (During On-Off action at P=OFF,  : 0.0% and  : 100.0% though 9999 represents 100.0% in the monitor screen.)

7-8. Setting of Set Value Bias (Sb) "Mode 0-5" (Optional)

If a bias amount is previously set in the set set value, the initial set set value added with the bias amount makes a set value when the SB terminals go on (short circuited).

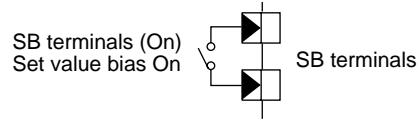

SB terminals (On) = Set set value (SV) + bias value (Sb)

SB terminals (Off) = Set set value (SV)

7-9. Setting of Current Values for Heater Break and Heater Loop Alarms (Optional)

Note:

- This function cannot be used when current (I) or voltage (V) is selected as the control output.
- When OFF is set in the heater break/loop alarm setting screen, no alarm is output.
- Since the heater break alarm and heater loop alarm are output from the same alarm output terminal (HB) and use the same alarm lamp, the value of the heater current should be checked in the "Mode 1-1" screen to know which alarm is to be output.
- The heater break/loop alarm function can be used only in a single-phase AC circuit. It cannot be used in a DC-load circuit, phase control circuit, or 3-phase load circuit.
- A CT for the current selected by the Code Table is included as an accessory. Only a CT of the specified model can be used.

- The heater break alarm and heater loop alarm can be used when the control output is contact (Y) or SSR drive voltage output (P).
- Alarm Set Value
Set the heater break alarm at about 85% of the value of input from the current transformer (CT) or lower when the power supply fluctuates significantly.
- If more than one heater is connected in parallel, a slightly larger value should be set so that an alarm can be output even if only one of them breaks down.
- Current transformer (CT)
Current transformers (CT) for 30A and 50A are available.
- How to connect current transformer (CT)
Insert a load line through the hole specially prepared for the CT. There is no polarity with the wiring from the CT to the controller.
- A heater break alarm is output when the CT detects the heater current while the control output is on. The alarm is activated by the abnormality of the detected current value being lower than the set current value.
- A heater loop alarm is output when the CT detects the heater current while the control output is off. The alarm is activated by the loop abnormality of the output circuit when the detected current value is higher than the set current value.

- Selection of heater break alarm output mode

				Process value (PV)
		└		Set value (SV) └ : Lock mode ┐ : Real mode

Use the & keys to select └ or ┐ and register it using the key.

You can select Lock mode or Real mode for the alarm output mode. The mode can be selected in the function selection screen "Mode 2-1" (see page 19).

7-10. Operation of Keylock (LOCK) "Mode 1-18"

This function inhibits the changing of various parameters and set value, the setting of auto tuning, manual control, etc., and a mode change by front key operation. The function can be used to prevent erroneous operation after the completion of setting.

Select keylock mode by key.

Select the mode using the and keys for setting and the key for registration. To release Keylock, select the same mode and set OFF. Then press the key.

Type of Keylock	Description
oFF	All locks released
1	Only SV, AT & MAN can be changed.
2	Only SV can be changed.
3	All settings are locked.

* When a setting cannot be changed during operation, check whether keylock is on.

7-11. Automatic Return of Display Screen

If there is no key input for 3 minutes or longer in any screen other than OUT /control output display and Hb_A /heater current process value display, the basic screen "Mode 0-0" returns automatically.

8. Error Messages

8.1 Problems with Process Value Input

The control output upon sensor detection of abnormality becomes 0% regardless its characteristics.

- (1) Thermocouple has burnt out, A of R.T.D has burnt out, PV value exceeds the higher limit of the measuring range (scaling value for voltage or current input) by about 10%.
- (2) PV value is below the lower limit of the measuring range (scaling value in voltage for current input) by about 10%.
- (3) For thermocouple input, the reference contact circuit (CJ) has gone out of order on the higher limit side.
- (4) For thermocouple input, the reference contact circuit (CJ) has gone out of order on the lower limit side.
- (5) For R.T.D. input, B (upper) of A, B (upper), B (lower) has burnt out or both A and B (lower) have burnt out.
- (6) For R.T.D. input, B (lower) of A, B (upper), B (lower) has burnt out or the resistance has dropped very low.

8-2. Problems with CT Input for Heater Break Alarm (HB)

- (1) The control action that has turned on or off does not go on normally.
- (2) The CT input value exceeds the higher limit of the measuring range by about 10%.
- (3) The CT input value is below the lower limit of measuring range by about 10%.

- The above display appears when Hb_A is selected.



PO Box 60
Thompson Ridge, NY 10985
website: www.vespo.com

Phone: (800) 49-VESPO
Fax: (800) 36-VESPO
email: controls@vespo.com